

**Section 2 – 200 Amp and Smaller - Common**

2-0 General Metering Requirements ..... 2  
2-1 Basic Calculations ..... 4  
2-2 100-200 Amp Single-Phase UG ..... 5  
2-3 100-200 Amp Single-Phase UG with Main ..... 6  
2-4 100-200 Amp Single-Phase OH ..... 7  
2-5 Temporary Services ..... 10  
2-6 Mobile Home Services ..... 13  
2-7 100-200 Amp Three-Phase OH or UG..... 17

## **2-0 General Metering Requirements**

### **Single Phase 120/240**

#### 200 amp meter socket

UL-listed, ringless, bypass horns or lever, sealable, and no cover over the meter. Require 200 amp pedestals for all underground installations. See subsection 2-2 and 2-3 for list of possible acceptable manufacturer catalog numbers for underground installations. There is no list of possible acceptable manufacturer catalog numbers for overhead service installations. Overhead service meter sockets must be rated at least 100 amps.

#### 400 amp, class 320 meter socket

Rated 320 amps continuous, 400 amp intermittent. UL-listed, ringless, bypass lever, sealable, and no cover over the meter. Require pedestals for all single meter, underground installations. See subsection 3-1 for list of acceptable manufacturer catalog numbers. There is no list of possible acceptable manufacturer catalog numbers for overhead service installations.

#### 400, 600 or 800 amp CT metering

This involves a CT cabinet on the outside of the building for underground services (see subsection 3-4). See WEB subsection 5-8 for overhead service installations.

### **Single Phase 120/208**

#### 200 amp meter socket

Need a fifth jaw added in the 9 o'clock position (see subsection 5-4 in the WEB version). UL-listed, ringless, bypass horns or lever, sealable, and no cover over the meter. Require 200 amp pedestals for all underground installations. See subsection 2-2 and 2-3 for list of possible acceptable manufacturer catalog numbers. There is no list of possible acceptable manufacturer catalog numbers for overhead service installations. Overhead service meter sockets must be rated at least 100 amp.

### **Three Phase 120/208**

#### 200 amp meter socket

Seven jaw, UL-listed, ringless, bypass lever, rated 200 amp, sealable, and no cover over the meter. Require pedestals for all underground installations. See subsection 2-7 for list of acceptable manufacturer catalog numbers.

#### 400 amp thru 2000 amp CT metering

Options for underground services include a CT cabinet on the outside of the building (see subsection 3-4) or CTs inside of a padmount transformer (see subsection 3-6). See WEB subsection 5-8 for overhead service installations.

**2-0 General Metering Requirements (cont'd)****Three Phase 277/480**

## 200 amp meter socket

Seven jaw, UL-listed, ringless, bypass lever, rated 200 amp, sealable, and no cover over the meter. Require pedestals for all underground installations. See subsection 2-7 for list of acceptable manufacturer catalog numbers.

## 400 amp thru 3000 amp

Options for underground services include a CT cabinet on the outside of the building (see subsection 3-4), CTs inside of a padmount transformer (see subsection 3-6), or a CT cabinet inside for 2500 amp and larger installations with special permission (access issues) (see subsection 5-6 and 5-7 in the WEB version). See WEB subsection 5-8 for overhead service installations. Note that the K-7 bolt in meter socket is no longer acceptable for 277/480 installations.

**Multiple Metering**

1. See subsection 3-11 for smaller installations and subsection 5-5 in the WEB version for larger installations.
2. There is no list of approved catalog numbers. The same basic requirements for single meter installations apply. Note the utility cable termination clearance requirements in subsection 3-5.
3. Pedestals are desirable for residential, duplex single phase installations, but not required. Note that only one electric service can be run to a residential duplex.



## 2-2 100-200 Amp Single-Phase UG

### 200 Amp Single Phase UG Pedestals

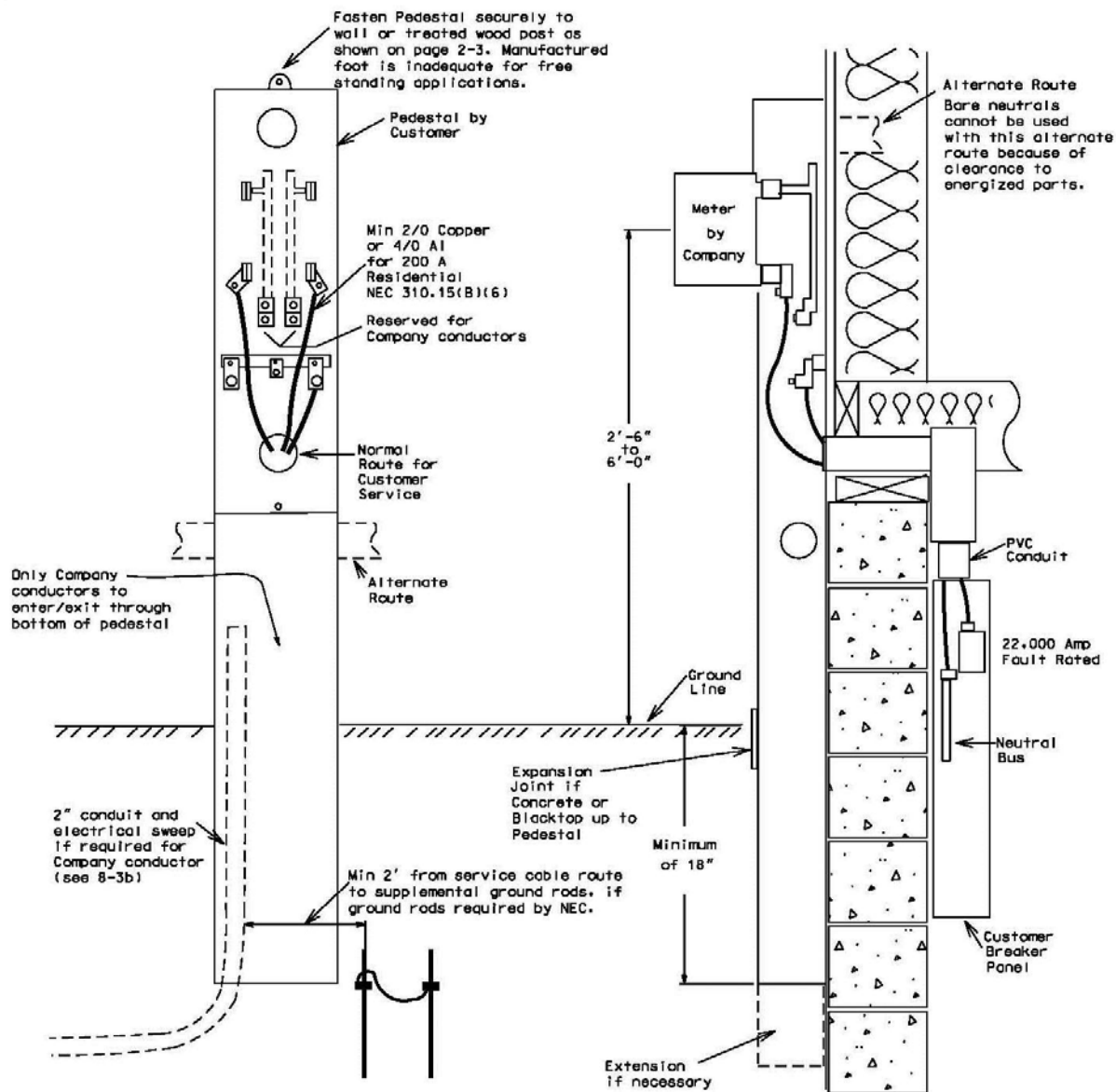

Notes:

1. The pedestal cannot be used for other customer wires such as a feeder out to the garage (NEC 230.7).
2. All meter pedestals must be ringless, have minimum of horn bypass, be sealable, and be UL-listed.
3. Only pedestals are allowed for underground because of frost heave problems.

Possible acceptable catalog numbers. Extension only needed if required for height reasons.

Milbank	U3358-0-KK	Ext. K5800 (15")
Schneider Electric	UHT-RP2423-63	Ext. 1007680 (18") or 1008786 (30")
Cutler Hammer	UHT-RP2423-63-CH	ext. 1007680-CH (18") or 1008786-CH (30")
Midwest	UHT-RP2423-63-MEP	Ext. 1007680-MEP (18") or 1008786-MEP (30")
Landis & Gyr (Siemens)	UAP317-PPWI	Ext. 5007718
Durham	UHT-RP2423-63	ext. 1007680 (18") or 1008786 (30")

### 2-3 100-200 Amp Single-Phase UG with Main

#### 200 Amp Single Phase UG Pedestal with 4-6 Position Main Disconnect

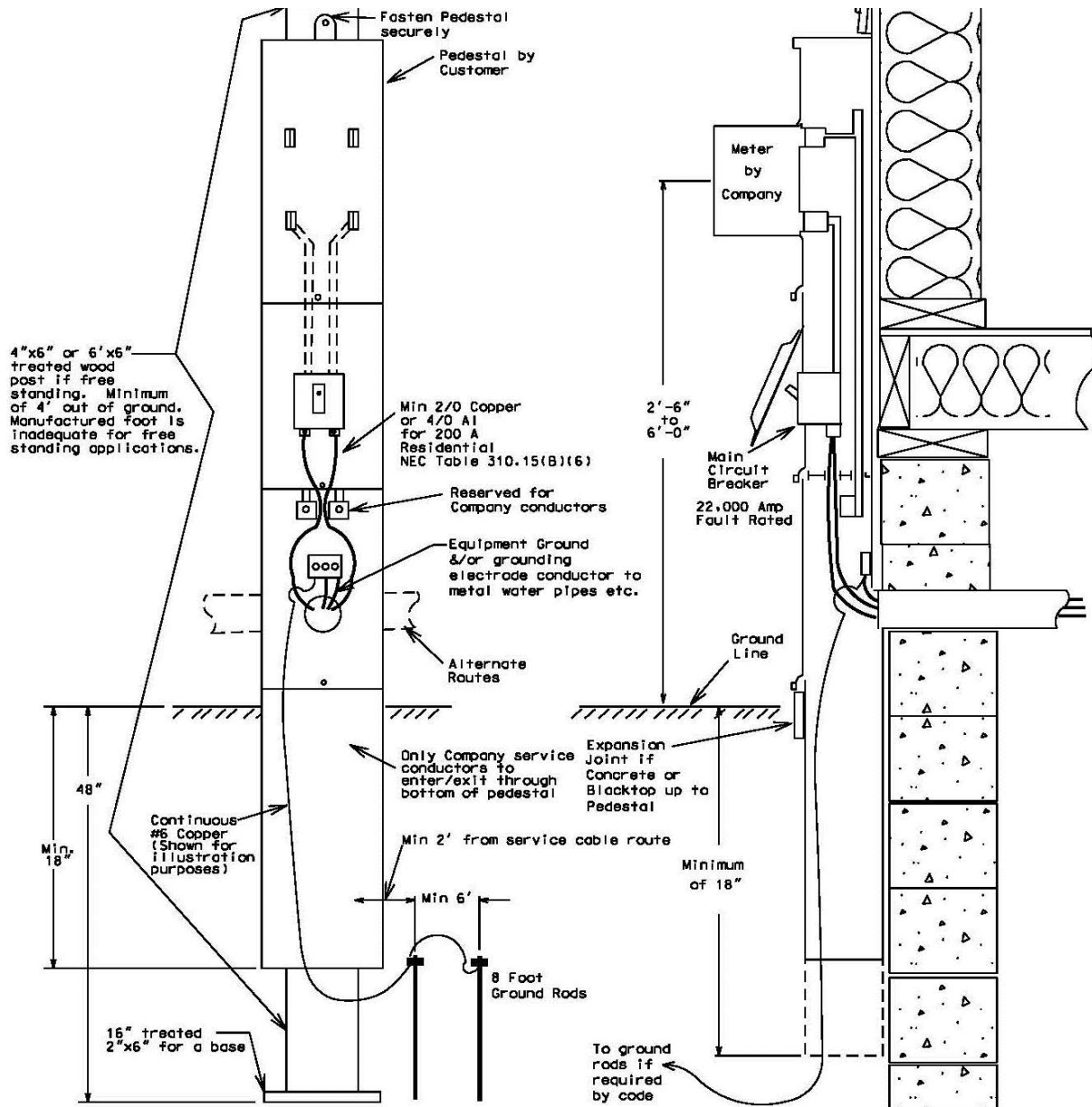

Possible acceptable catalog numbers. Extension only needed if required for height reasons.

Milbank	NU8980-0-KK	No extension available
	U5136-0-Series	No extension available
Cutler Hammer	1008846-CH	Ext. 1009021-CH (18") or 1009024-CH (30")
Durham	1008846 or 1009078 or 1008961	Ext. 1009021 (18") or 1009024 (30")

1. Must be attached to support post if free standing. Use a minimum of 8 foot, pressure treated 6X6 or 4X6. This must be buried at least 48 inches with a 16 inch treated 2X6 for a base.
2. This is commonly used if the service entrance conductor extends into the building longer than permitted by WI SPS 316.230(3) (8 foot rule) or by NEC 230.70(A) for MI. It is also acceptable to use a standard pedestal (subsection 2-2) and use a separate weatherproof disconnect.



2-4 100-200 Amp Single-Phase OH (Cont'd)

Option 2

Per NESC 234C3d (exception 2), this minimum is 18" for 120/240, if considered on inaccessible roof. 18" minimum applies for 6' radius of periscope. Clearance beyond that is 3' plus sag adders. A back guy is required.

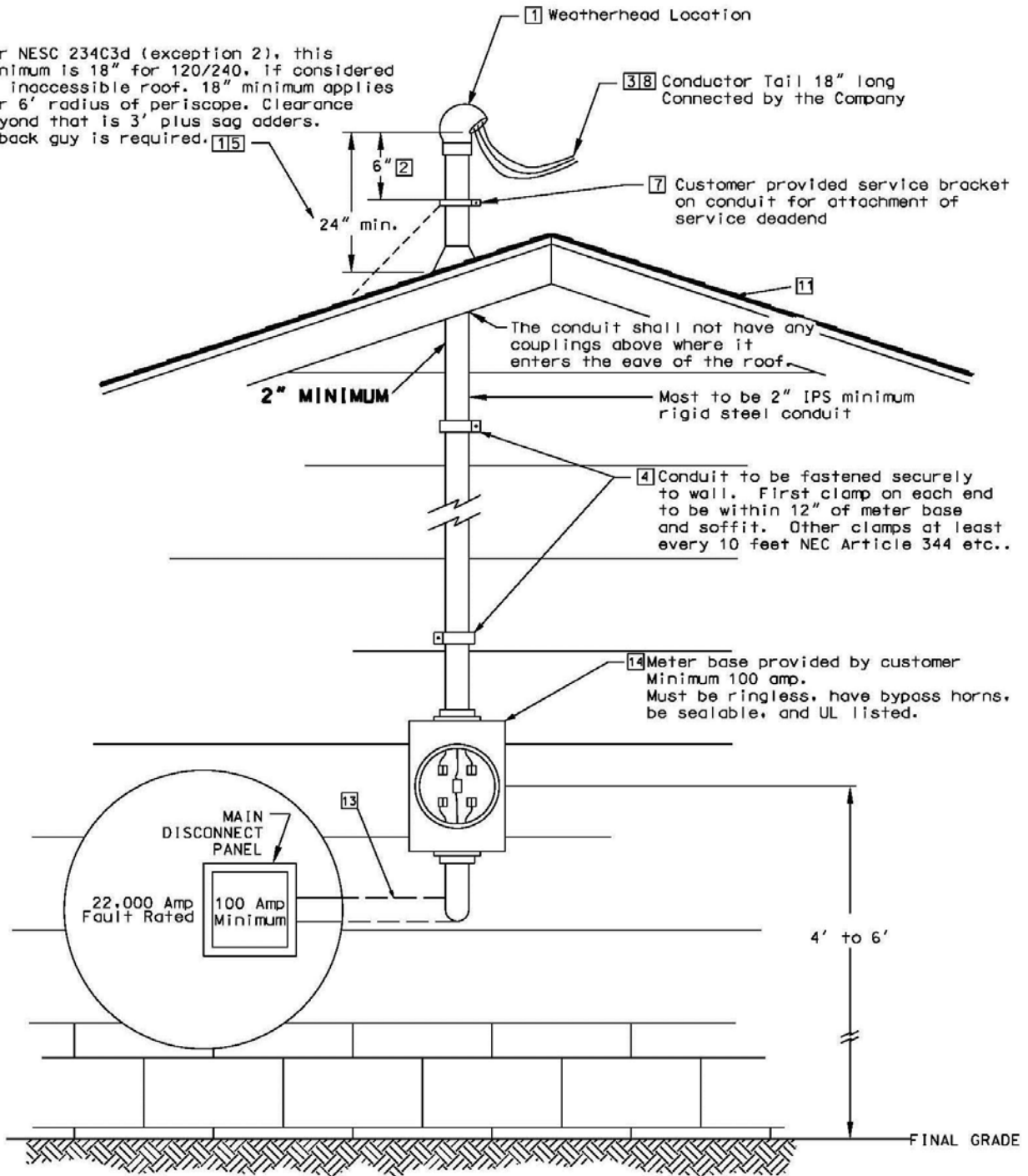



**2-4 100-200 Amp Single-Phase OH (Cont'd)**

## □ Notes:

1. Company employees must designate the service location and specify the mounting height of the periscope. This is required because of numerous code clearance issues with the overhead service drop conductors.
2. The weatherhead must extend at least 6 inches above the "attachment point" for the service drop. This "attachment point" must be installed by the customer. It must be adequately attached so it can handle 650 lbs. of line tension.
3. The conductor coming out of the weatherhead shall be at least 18 inches long. The Company will make the connections to the overhead service conductors.
4. The conduit shall be adequately supported with pipe straps. The meter socket shall also be adequately attached to the structure.
5. All periscopes (unsupported conduit extending above the roof) shall be made of rigid metal electrical conduit and shall be back guyed. Aluminum, IMC or thin wall are NOT acceptable. Minimum size shall be 2 inch for 0-200 amp, because of strength requirements. This includes upgrades to 100 Amps. No couplings can be above where the conduit enters the roof overhang or anywhere above the roof on the periscope.
6. If an overhead service is mounted on a pole or post, the pole or post shall be back guyed, having a minimum of a 6-inch dia. top, and be pressure-treated with a wood preservative. An alternative is a minimum 6" x 6" treated timber. This pole or post location, height, and burial depth shall be approved by the Company.
7. Communication and customer-owned circuits cannot be attached to electrical entrance periscopes (NEC 230.28) but can be grandfathered if attached prior to 1996.
8. The neutral conductor shall be identified by white tape, white insulation, white paint, or other techniques approved by NEC Article 200 and 230.22.
9. Avoid wood decks when locating the meter socket.
10. Service entrance cable (rather than conduit) is acceptable, if installed properly, accepted by local inspection authority, and not placed behind any siding.
11. Supports used to support service-drop conductors to attain clearance over buildings should be avoided for new installations. For existing installations, they must be substantial and meet the requirements of NEC 230.29.
12. The drip loop and overhead service conductors must be placed at least 3 feet in any direction from windows (designed to open), doors, porches or similar structures. An exception is above the top level of a window. They must also not be readily accessible. [NESC 234 C3d(2)].
13. The main disconnect must be installed as close as possible to the entrance of the building and still in a readily accessible location. NEC 270.70(A). In Wisconsin, this is also limited to eight feet. If conduit or cable is under siding or bricked in, it is considered as already inside the building for WI SPS 316. 230(3).
14. A minimum of 3 feet must be provided in front of all metering installations and 6'6" of vertical headroom. See NEC 110.26(A) for details.
15. **The Company has no list of approved sockets for this application. The only requirements are that they be UL-listed, be a minimum of 100-AMP rated, ringless style, have horn bypass, and be sealable. The meter base shall be securely mounted. NEC 110.13(A).**

## 2-5 Temporary Services

### (Option 1, Overhead)

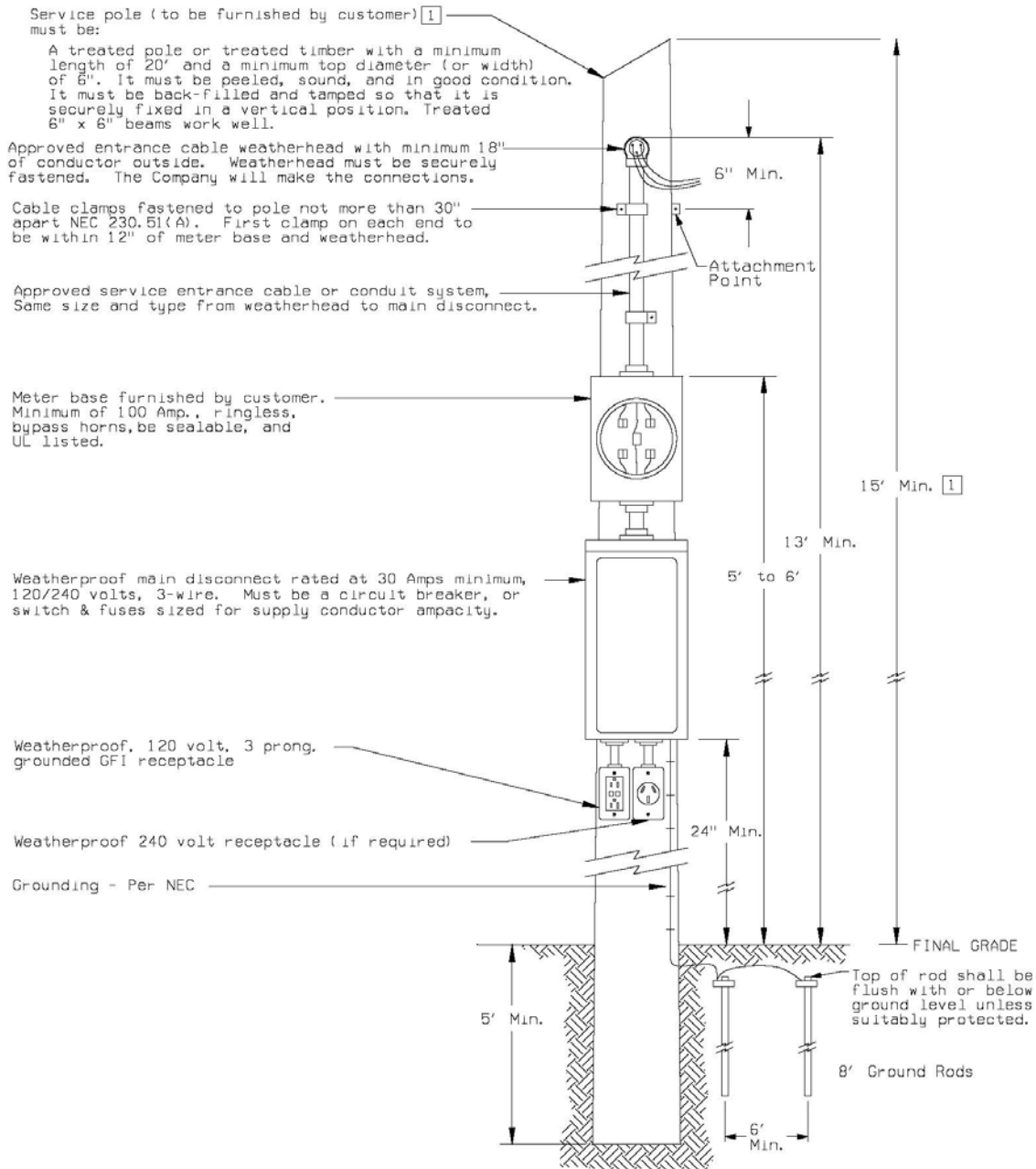

□ Notes:

1. Customer must furnish and mount all service entrance equipment and set pole in the ground. Pole or post location and height to be determined by the Company and coordinated with customer prior to installation. There are numerous overhead clearance requirements. The maximum length for temporary overhead service is 125 feet.
2. Temporaries are intended for short-term use.
3. This pole must be backguyed and anchored by the customer if greater than 10 ft. from the Company pole. An alternative is the use of two 2" x 4" push braces staked into the ground.
4. 22,000 amp fault-rated breaker required.

**2-5 Temporary Services (Cont'd)**

**Temporary Services (Options 2 through 5)**

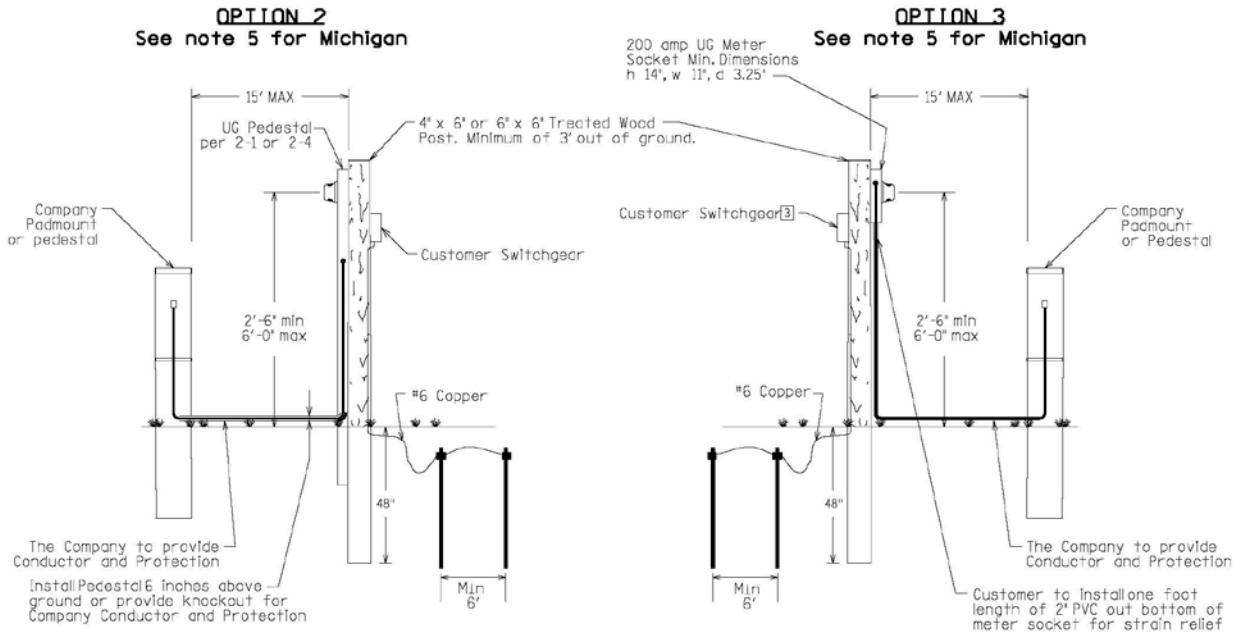

**Option 4**

Same as Option 1, except served from a Company padmount or pedestal. Temporary can only be a maximum of 15 feet away, and the Company to provide conductor and protection (running cable on ground and up temporary pole to the customer conductors near the weatherhead). The termination of the Company conductors must be between 10 feet (min. drip loop clearance per code) and 15 feet above ground (concern with temporary tipping over with ladder up against it). See note 5 for Michigan.

**OPTION 5**

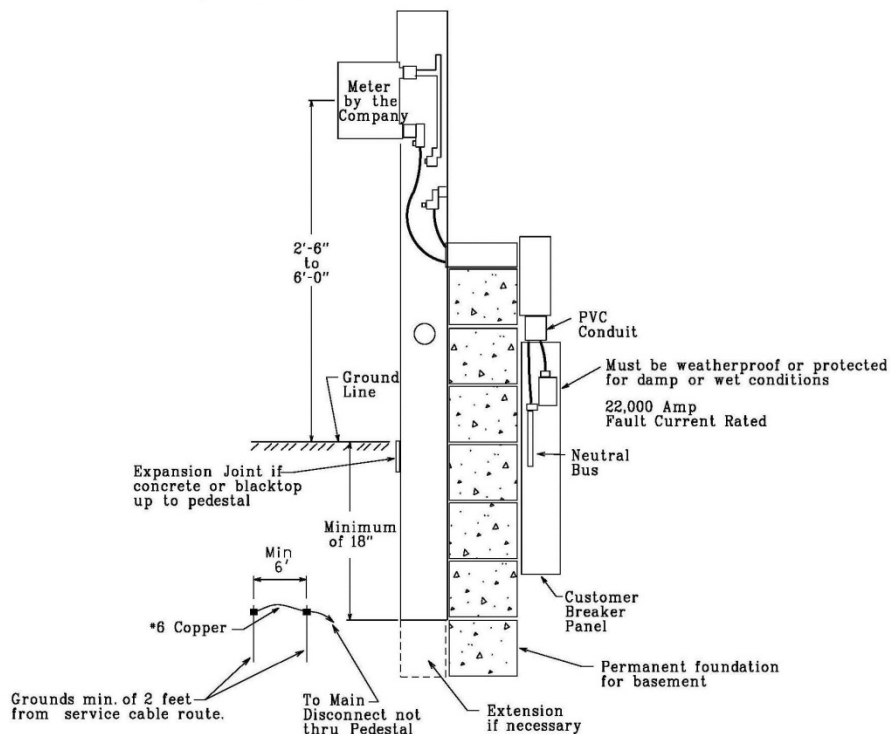

## **2-5 Temporary Services (Cont'd)**

### Notes:

1. The Company shall specify the location of temporary service poles. Care must be taken to avoid the permanent service route. Potential clearance problems must also be avoided.
2. Temporary services are intended only for a short use. If the temporary service is expected to be used longer than one year, see Sections 2 or 3 for permanent installation instructions.
3. Junk equipment, such as 60 Amp meter sockets and old indoor 60 Amp fuse panels, are not acceptable for temporaries. If the Company must make return trips because of clearance problems or unsafe equipment, there may be additional charges.
4. Option #5 shows how to install a permanent meter pedestal and breaker panel and how to avoid using a temporary service. The breaker panel must either be weatherproof or protected from a wet or damp environment. The basement walls must be backfilled and adequately tamped for the Company to run the permanent underground service. Another option is to use approved flexible conduit between the meter pedestal and the breaker box. See subsection 2-2 for details on permanent underground services.
5. In Michigan, the source side utility conductors must be buried, if fed from an underground system. The maximum distance is reduced to 10 feet for Michigan.
6. **22,000 amp fault-rated breaker required for all temporary services.**

## 2-6 Mobile Home Services

### (Option 1, Overhead)

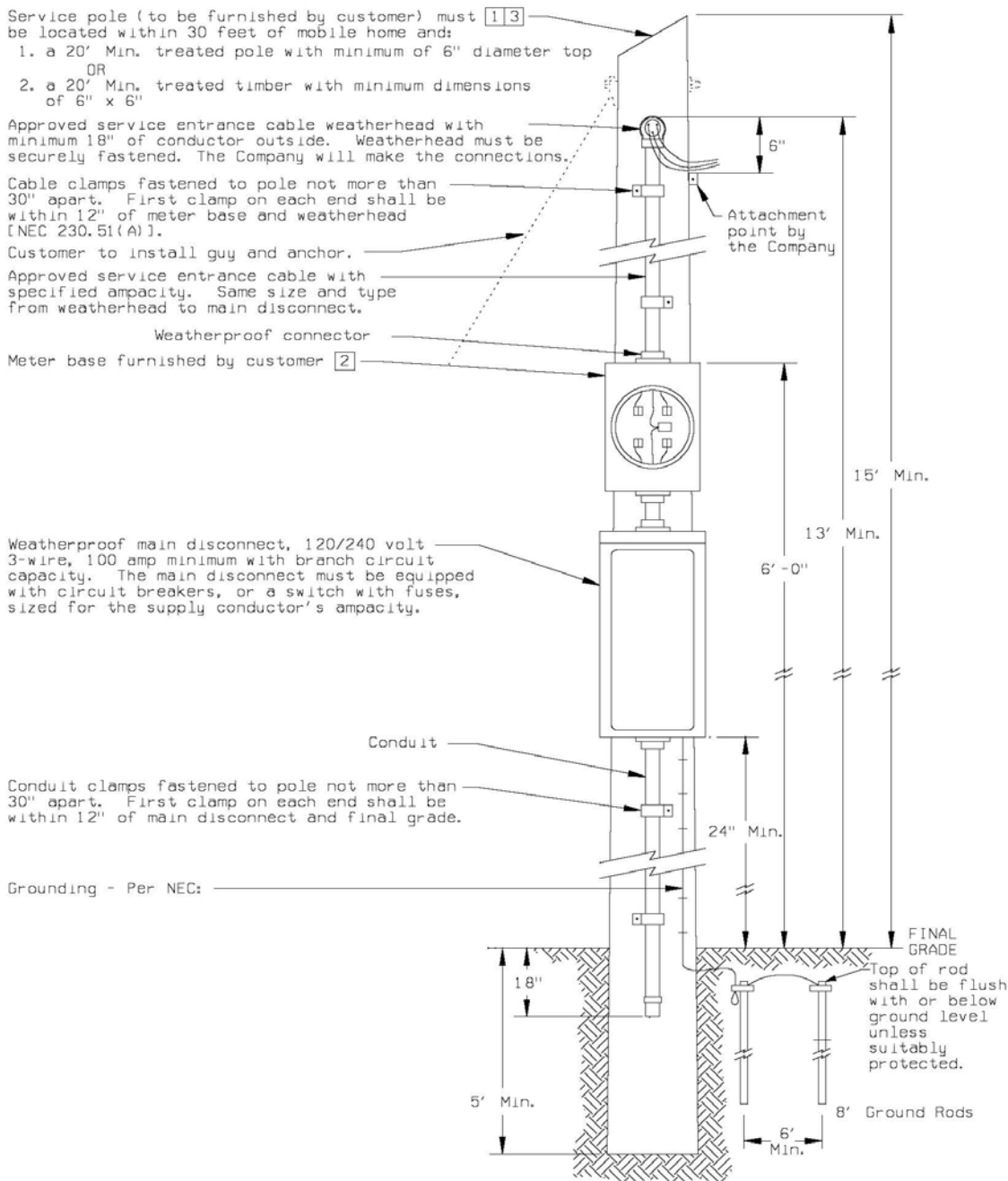

□ Notes:

1. Customer must furnish and mount all service entrance equipment and set pole in the ground. Pole or post location, height, and burial depth to be determined by the Company and coordinated with customer prior to installation.
2. Face meter toward driveway or street for meter reading reasons.
3. Meter pole must be within sight of and not more than 30' from the exterior wall of the mobile home (NEC 550.32).
4. The Company must designate the service location. There are numerous clearance issues. See subsection 7-1 for overhead clearances. Note that service drops over the home are often a problem.

**2-6 Mobile Home Services (Cont'd)**

**Mobile Homes  
(Option 2 and 3, Underground)**

**Option 2 – Requires assembly of individual components**

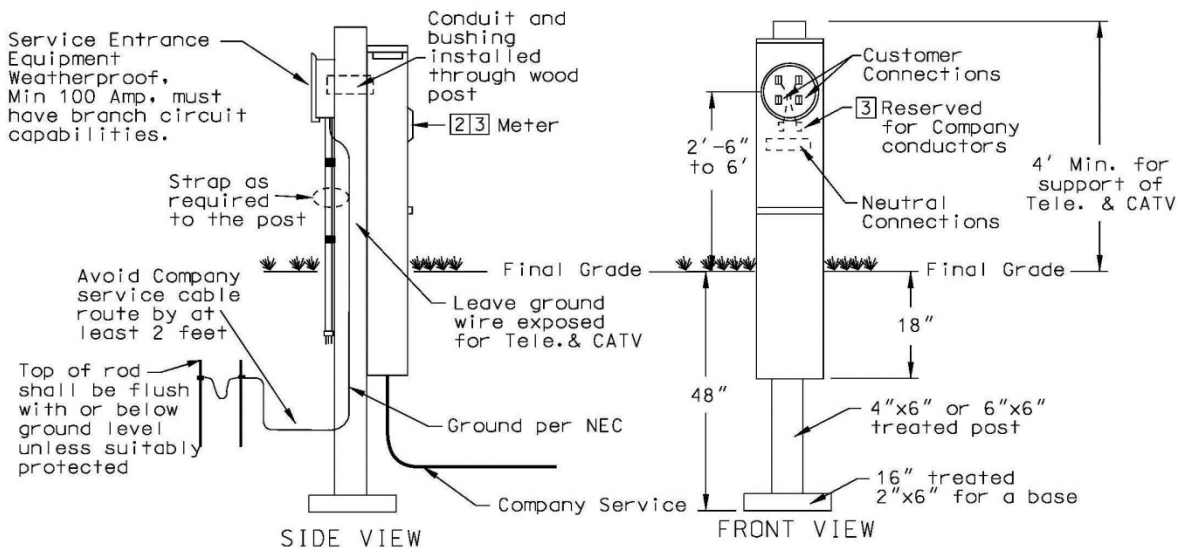

□ Notes:

1. Face meter toward driveway or street, and away from mobile home.
2. Label installation if not obvious as to which mobile home is fed.
3. Service location must be within sight of mobile home and not more than 30' from the exterior wall of the home (NEC 550.32).
4. See subsection 2-2 for possible approved manufacturers list for pedestals.

**Option 3 – Premanufactured Installation**

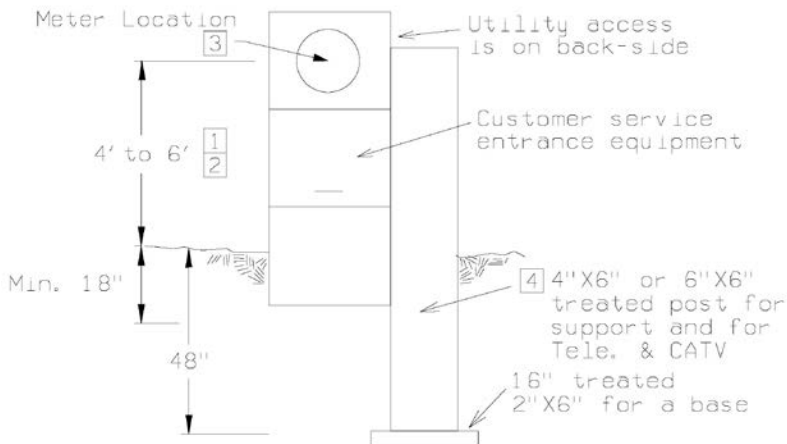

**Option #3 – Pedestals.** The Company standard meter socket is 100 amp minimum (200 amp if underground), ringless, horn style bypass (minimum), UL approved, sealable, and no covers allowed over the meter. Premanufactured mobile home meter pedestals must be Nema 3R rated and have disconnects meeting the requirements of NEC 550.32. Recreational-style meter pedestals are not acceptable. Consult the Company with questions.

**Option #4 – Free-Standing Pedestal with Support Post**

See subsection 2-3 for approved manufacturer list. (Need 4x6 or 6x6 treated wood post). Do not use camper-style meter pedestals.

## 2-6 Mobile Home Services (Cont'd)

### Mobile Home General Information

Notes:

1. **Definition:**

A mobile home as defined by the NEC 550.2 is as follows: "A factory assembled structure or structures transportable in one or more sections, that is built on a permanent chassis and designed to be used as a dwelling without a permanent foundation where connected to the required utilities, and that includes the plumbing, heating, air conditioning, and electric systems contained therein." Mobile homes can be identified by a red rectangular Department of Housing and Urban Development (Federal HUD) inspection label on the outside corner of the home. Manufactured homes (Ex. Wausau Home), on the other hand, can be identified by a state inspection sticker on the electrical panel or inside of the closet door or similar location. These are often referred to as UDC homes (Uniform Dwelling Code).

2. **General Code:**

Mobile homes are built and inspected by the Federal Department of Housing and Urban Development. The external electrical wiring for mobile homes is covered by State Electrical Inspection requirements. As per the electrical code, a mobile home is always a mobile home. That is different than many local zoning ordinances. Zoning ordinances often allow mobile homes to be redefined if they are mounted on a permanent foundation. The external electrical wiring requirements for a mobile home are covered under NEC 550 with specific information on the service entrance equipment under NEC 550.32.

3. **Practical Effect:**

Mobile homes must be fed with an external electrical meter and external disconnect as per NEC 550.32. The NEC also requires provisions for a feed from that disconnect to an accessory building or other piece of equipment (such as a well). Provisions should also be made for a 15 or 20 amp, 120 volt GFI outlet. The NEC requires the disconnect to be located in sight of the mobile home and not more than 30 feet away. The electrical meter and disconnect cannot be attached to the mobile home (can be fastened to a permanent foundation or basement). The wiring from this external service entrance equipment into the mobile home must be four conductor (two hots, a neutral, and an equipment ground (green or bare)). The NEC requires this conductor to be in conduit where exposed under the mobile home.

The only way around the external disconnect is if the mobile home is mounted on a permanent basement. In this case you are actually feeding electricity to the basement with a sub feed to the mobile home. Crawl spaces do not work for this because of the head room requirement of 6.5 feet as per NEC 110.26. Also note that NEC 230.70(A)(1) requires the main disconnect to be located "nearest the point of entrance of the service conductors." Yet another issue is that the electrical panel in many mobile homes is not rated as "Service Entrance" equipment.

4. **Mobile Home Parks:**

The Company requires that all new mobile home parks be built with an underground electrical system. This is because of numerous overhead clearance problems in mobile home parks. Metering pedestals must also be labeled if it is not obvious as to which home is fed from the pedestal (NEC 110.22).

5. **Meter Direction:**

The electrical meter needs to be positioned so it is pointed toward the driveway or street. Do not position the electric meter so it is pointed toward the mobile home. The reason for this is the ability to read the electric meter.

**2-6 Mobile Home Services (Cont'd)****6. Overhead Installations:**

The critical need on overhead installations is a tall enough pole in order to obtain code-required clearances on the service drop to the customer service pole. The following are common basic clearances (additional clearance is required to account for thermal and ice loading):

- |    |   |   |
|----|---|---|
| A. | Over the mobile home or garage roof (not readily accessible). | 8 feet for Wisconsin<br>(3'6" for Michigan) |
| B. | Pedestrian only area.   | 12 feet                                     |
| C. | Roads, streets, alleys, parking lots, driveways.              | 16 feet                                     |
| D. | Horizontal clearance from wells.                              | 14 feet for Wisconsin                       |

The electric meter base needs to be at least 100 amp, 120/240 volt rated, have a horn bypass, and be UL approved, and sealable. There is no "Approved" list for meter bases from the Company for overhead installations.

**7. Underground Installations:**

On underground installations, the Company requires a substantial support (treated wood posts) as per the included specification. This is because of frost heave problems in the area. The pre-manufactured mobile home pedestals do not provide enough support for frost heave problems.

Diggers Hotline 811



# WPS SERVICE MANUAL

Revised 06/2018

**Section 2 200 AMP AND SMALLER - COMMON**

Page 17 of 17

## 2-7 100-200 Amp Three-Phase OH or UG

### View of Meter Sockets

#### VIEW OF METER SOCKETS

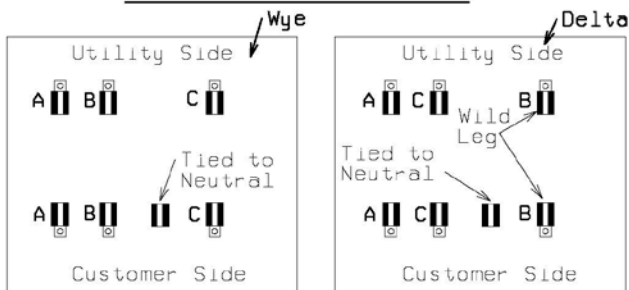

7 Jaw Meter Socket

Used for:  
 120/208 4-wire 3 Ø wye  
 277/480 4-wire 3 Ø wye  
 120/240 4-wire 3 Ø delta

For 120/240 4-wire 3 Ø the far right side shall be connected to the wild leg. This conductor shall be identified with orange tape or marked by other approved means.

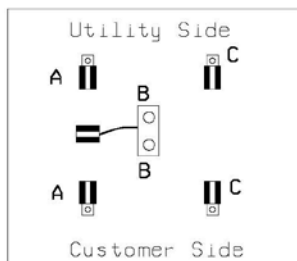

5 Jaw Meter Socket  
 Used for 240 Volt  
 3-wire 3 Ø Delta  
 The center conductor is the grounded conductor.

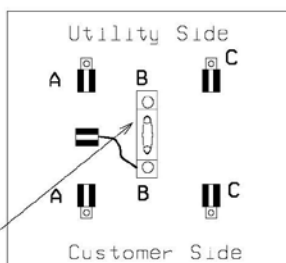

5 Jaw Meter Socket  
 Used for 480 Volt  
 3-wire 3 Ø Delta  
 The insulated slide bar is used to disconnect the third phase, if necessary.

Insulated Slide bar

### Basic Meter Socket Requirements

1. Ringless style, 200 Amp minimum rated, clamp type jaws, 600 volt rated, sealable, and provided with protective shield covering the jaws.
2. The meter sockets shall have a manual bypass that is designed so the cover cannot be installed with the bypass closed.
3. The phase designations are commonly used designations by electricians. They do not indicate clockwise or counterclockwise rotation.
4. This page is labeled using customer electrical design standards of B phase wild or grounded B phase. Unfortunately, the utility industry calls this C phase.

### Approved Meter Sockets

	7 Jaw 120/208 277/480 120/240	7 Jaw 120/208 277/480 120/240	5 Jaw 3-Wire 3 Phase
Type	UG Pedestal	OH Only	OH or UG
Similar to	p.2-2	p.2-4	p.2-4 & 3-2
Midwest	-	UTH7203T-MEP	U42552-NO-HO
Landis & Gyr (Siemens)	40407P-9WI	40007(HQ-7)	9804-8592 (5 NDU)
Schneider Electric	-	UTH7203T	-
Milbank	U9107-0 & S3488 (ext.)	U9700-XL; U9701-XL	-
Cutler Hammer	-	UTH7203T-CH	-
Durham	-	UTH7203T	-