

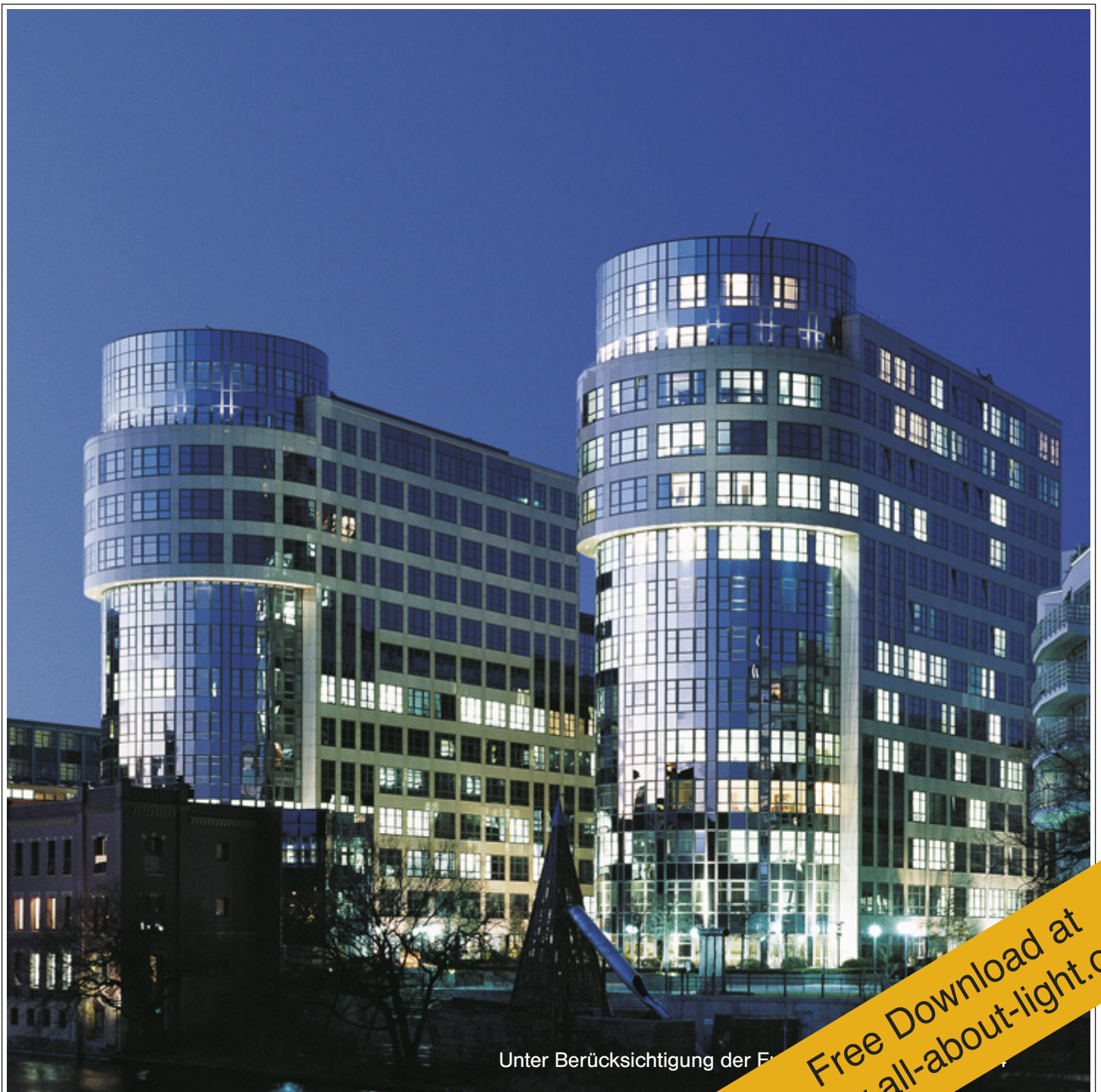

# Good Lighting for Offices and Office Buildings 4



Unter Berücksichtigung der F

Free Download at  
[www.all-about-light.org](http://www.all-about-light.org)

Office work	2 / 3
Office space	4 / 5
Office lighting / types of lighting and lighting concepts	6 / 7
Cellular offices	8 / 9
Group offices	10 / 11
Combi offices	12 / 13
Open plan offices	14 / 15
Prestige offices	16 / 17
CAD offices	18 / 19
Conference rooms / training rooms / video-conference rooms	20 / 21
Offices open to the public	22 / 23
Reception rooms and areas	24 / 25
Cafeterias / staff restaurants / rest rooms / communication zones	26 / 27
Outdoor areas / façades	28 / 29
Lighting technology	30 – 35
Minimum lighting requirements	36 / 37
Lamps	38 / 39
Luminaires	40 – 43
Lighting management	44 – 46
Literature, standards and LiTG publications	47
Acknowledgements for photographs / Order forms	47
Imprint	48
Information from Fördergemeinschaft Gutes Licht	49





Vision is the most important of all the five senses – and the one we rely on most heavily at work. So correct workplace lighting is a matter of particular importance. As numerous scientific studies have shown, close links exist between the quality of lighting on the one hand and productivity, motivation and well-being on the other. In the modern working world, however, we need more than just the right amount of light for workplace tasks. We need a succession of stimulating and relaxing situations throughout the day. So creating different lighting scenes in rooms with different functions (workrooms, meeting rooms, recreation/regeneration zones) helps boost motivation and promote a sense of well-being.

Prof. Dr.-Ing. Dipl.-Wirtsch.-Ing. Dieter Lorenz  
Giessen-Friedberg University of Applied Sciences



Nothing in the working world has undergone such a radical transformation in recent years as office work. With rapid advances in information and communication technologies, corporate structures in a state of flux and totally new forms of work emerging, today's world of work is a world of computers and networks, workflow and data exchange. Office work has become information and communication work.

But changes in the way we work also impact on other areas of our private and working lives. The knowledge society of the 21st Century needs different offices, differently designed buildings, even different urban design. The industrial kind of office work, where people streamed to their cellular offices in the morning and streamed back to their homes outside the town or city centre in the evening, is being replaced by new, flexible, personalised working arrangements.

The traditional form of office work, where each employee performs one operation at his or her desk, has been superseded in many modern companies and organisations by more efficient forms of work such as project-oriented teamwork. Here, specialised teamworkers meet at various locations in various constellations for limited sessions of cooperation. Their office equipment consists of mobile phone, laptop computer and PDA (Personal Digital Assistant) and they decide for themselves where, when and with whom they work.

Flexible working times and flexible work locations, non-territorial offices and mobile workstations present new architectural requirements for the places where we work. Individual work is done at home in a home office or at customers' premises, in combi offices or in a recreation zone. Company buildings are thus becoming communica-

tion centres, places for employees to meet and exchange information. Key facilities here are conference zones, conference rooms and cafeterias – places where teams can come together for formal or informal meetings.

The "office building" system as a whole has thus clearly become more complex. What is more, employers increasingly insist on company buildings being designed to make a cohesive visual statement in tune with the organisation's corporate design. From façade to reception area, cellular office to combi office, executive office to office areas open to the public, every element needs to suit the company's style.

The architect thus becomes an all-rounder, designing colour schemes and furnishings, lighting and air-conditioning as elements of an integrated system. The primary gearing of that system, however, is dictated by the need to ensure efficient organisation of labour. Above all, employees need a motivating, performance-enhancing atmosphere, which is now widely known to be promoted by an agreeable working environment. In short, the challenge lies in creating an ambience for work which is both functional and agreeable.

A major role here is played by correct lighting. This forms an important part of the office building system as a whole because it paves the way for good visual performance and comfort at work and significantly affects the way we respond to the architecture of the building and the design of the interiors.

### How will office design and office workplaces change in the next five years?

German executives' answers to this question were as follows:

- 71,9 %:** Offices will be more variable.
- 66,1 %:** Office space will be more intensively used.
- 56,9 %:** Offices will be modifiable.
- 50,7 %:** Rooms and workplaces will underline the value of personnel.
- 45,6 %:** There will be totally new types/forms of office.
- 9,8 %:** Not much will change.

Source: Deutsches Büromöbelforum, Düsseldorf, 2001; target group survey by BBE-Unternehmensberatung GmbH, Cologne

### How do you see office design and office work in five years' time?

German executives' answers to this question were as follows:

- 71,8 %:** The office will remain the principal location for work.
- 60,5 %:** Changes as a result of communication technologies.
- 44,3 %:** Seamless transition between home and office, work and private life.
- 9,8 %:** Not much will change.

Source: Deutsches Büromöbelforum, Düsseldorf, 2001; target group survey by BBE-Unternehmensberatung GmbH, Cologne

### How will the pattern of demand for (special) office space change in the future?

GIM poll results:

	Today	In future	Change
<b>Open plan office</b>	6,6 %	5,1 %	- 1,5 %
<b>Group office</b>	12,7 %	11,7 %	- 1,0 %
<b>Cellular office</b>	80,7 %	37,6 %	- 43,1 %
<b>Combi office</b>	26,4 %	43,1 %	+ 16,7 %
<b>Flexspace office</b>	11,2 %	40,6 %	+ 29,4 %

Source: GIM Grundwert Immobilien Management GmbH, Dresdner Bank Immobiliengruppe, 1999



1

In modern forms of office, rigid room and workplace structures are being superseded by flexible and requirement-oriented concepts of use. In many cases, a kind of nomadic culture prevails, with employees able to use any workplace. This calls for new room architecture and more flexible furnishings: freely rearrangeable room structures, individually adjustable desks and office chairs, and variable lighting systems.

On the following pages, we look at modified types of office which meet these requirements. The new lighting concepts and lighting solutions crafted for them – as well as their realisation in line with the new European standard DIN EN 12464 and E DIN 5035-7 – are the focus of this publication. A matrix on the pages devoted to the individual types of office shows the kind of lighting recommended for the different applications.



2

FGL-3D-VISUALISATION ©



4

One modern innovation showing how the working world has changed and how many different forms offices and office work can take is the call centre.

The need for efficient sales support and qualified customer service worldwide make call centres an indispensable facility for many companies today.

The activities performed in a call centre are defined by new information and communication technologies: the primary tools are computer networks, databases and headset telephones.



3



3

Just as the way we work has been transformed, so too has the design of the rooms in which we work become more complex and diverse. The activities performed in offices today range from graphic design work on a VDU to multimedia presentations for colleagues and clients.

Regardless of the way offices are used, they can be divided into four basic types: the cellular office, the group office, the combi office and the open plan office. The most important form of office at present is the traditional cellular office. According to a study conducted by the Dresdner Bank Property Group (see page 2, table 3), 80.7% of all offices conform to this type. In the years ahead, however, we will see a dramatic decline in its significance. New flexible forms of office, such as the combi office or the flexspace (flexibly adaptable) office will be the norm in the working world of the future.

Production processes and building design, work hierarchies and room layouts, responsibilities and types of room – in the future, virtually no aspect of office work or its architecture will remain as it is today. Even the role of lighting will be reviewed. In the past, the primary purpose of office windows was to admit natural light and provide a visual link with the outside world; artificial lighting generally consisted of fixed luminaires arranged in line with the axes of the building. This arrangement then determined the positioning of workplaces in the room – and a central light switch permitted a choice between light and darkness.

In recent years, the design of all lighting components has become much more sophisticated. Regulating the daylight that enters a room – e.g. through the use of façade elements or window blinds – makes for better air conditioning, reduces artificial light-

ing costs, promotes a greater sense of well-being and thus heightens the motivation and operational efficiency of personnel.

Artificial lighting is seen as an architectural element. Lamps and luminaires are smaller and more efficient, they blend discreetly with the architecture or they strengthen its statement through their own design. Today, a variety of types of lighting are available to cater for every office activity and room situation. For example: direct/indirect luminaires with variable intensity distribution curves for agreeable ceiling illumination and glare-free workplace lighting, or flexible combinations of standard and desktop luminaires which move with desks.

Lighting control is a core element of any building management system. Central and local regulation of communications, air-conditioning, daylight control and artificial lighting systems makes building management more efficient and boosts productivity. Modern lighting control systems are designed for daylight-dependent and presence-dependent regulation, permit numerous lighting scenes and offer a high degree of operator convenience.

To ensure the right standard of lighting for a specific room use, the right balance needs to be struck between visual performance, visual comfort and visual ambience. The emphasis may need to be on

- visual performance, which is primarily defined by lighting level and glare limitation,
- visual comfort, which depends mainly on colour rendering and harmonious brightness distribution,
- visual ambience, which is essentially influenced by light colour, direction of light and modelling.

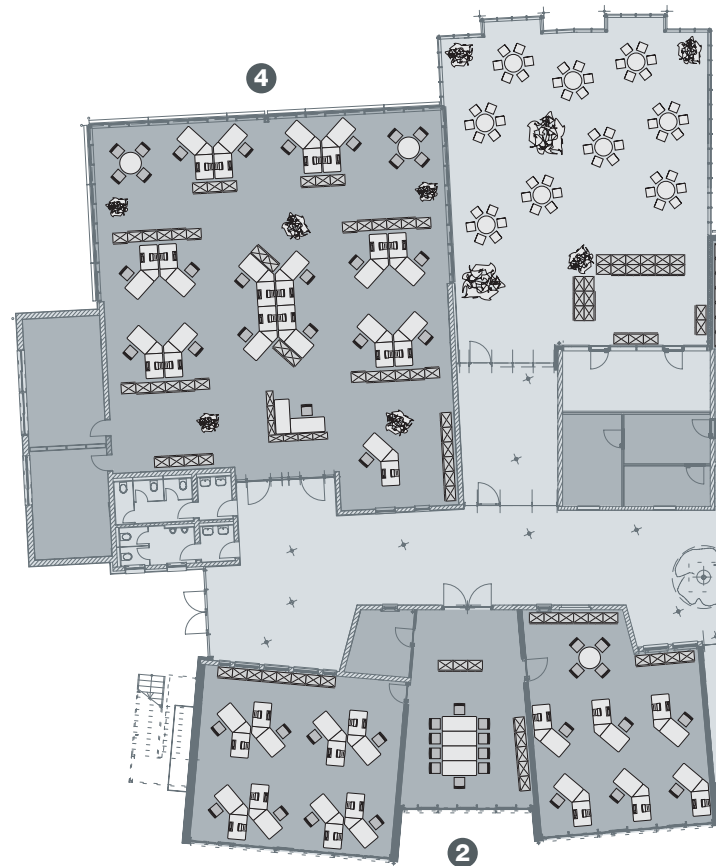

This office building floor plan shows the principal types of office and room, their salient features and the main access zones within the building.

### 1 CELLULAR OFFICES

- room area 10 to 50 m<sup>2</sup>
- room depth 4 to 5.5 m (single or double depth arrangement in buildings 12 to 14 m deep)
- room width approx. 2.5 to 4.5 m (1 to 2-person room)
- 1 to 6 employees per room
- storey height up to 4 m
- access to offices via corridor
- power/data cabling via window ducts, cavity floor or underfloor duct systems
- window-ventilated rooms, poss. partially air-conditioned (generally cooled)
- daylight-illuminated workplaces with occasional artificial lighting

### 4 OPEN PLAN OFFICES

- room area 400 to 1200 m<sup>2</sup>
- room depth approx. 20 to 30 m
- room width approx. 20 to 40 m
- 25 to over 100 employees per room
- storey height approx. 3.8 to 4.5 m
- non-corridor systems for workplace access
- power/data cabling via access floor or underfloor duct systems, sometimes suspended ceilings
- fully air-conditioned
- permanent artificial lighting in inner zones

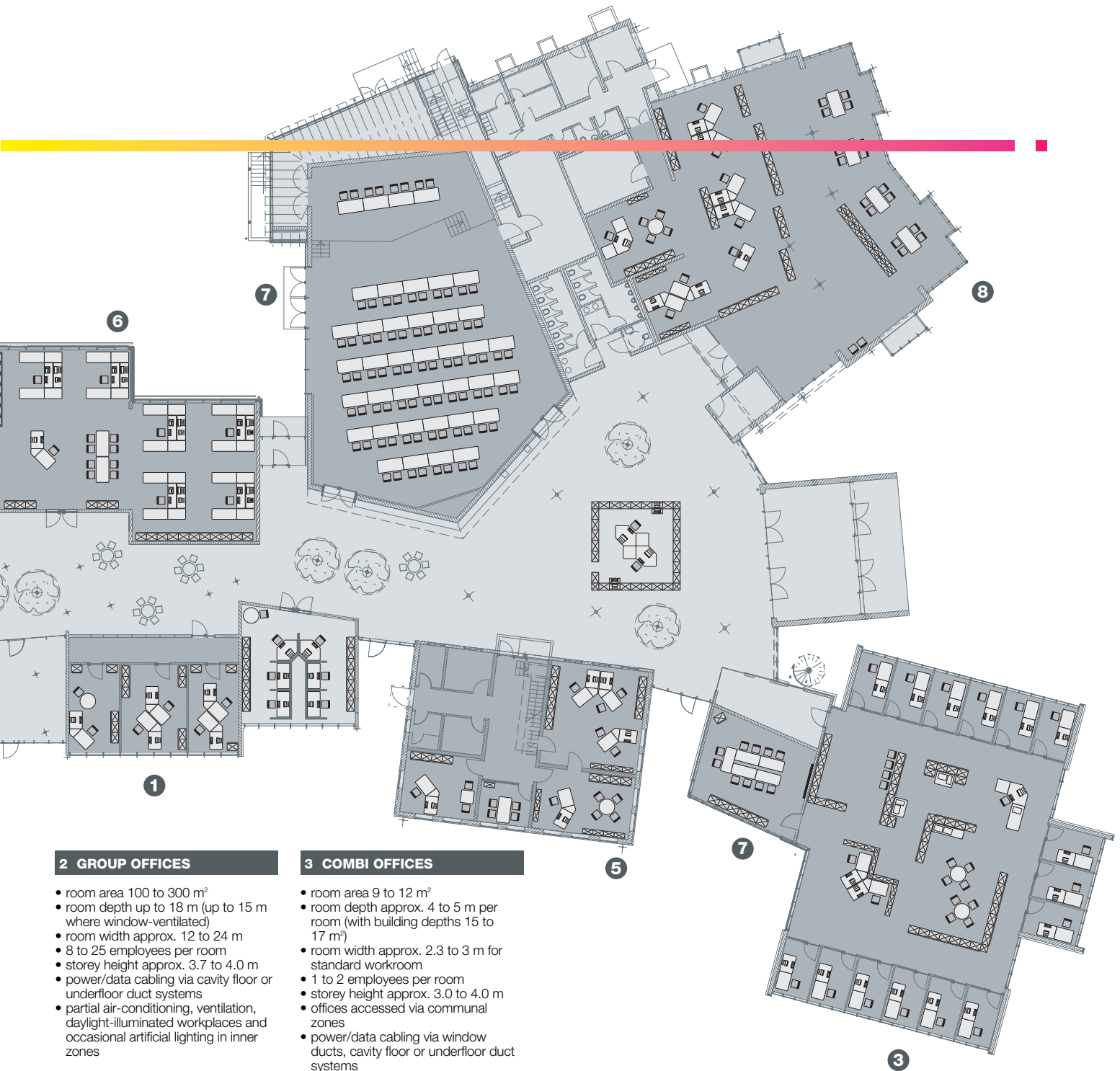

## 2 GROUP OFFICES

- room area 100 to 300 m<sup>2</sup>
- room depth up to 18 m (up to 15 m where window-ventilated)
- room width approx. 12 to 24 m
- 8 to 25 employees per room
- storey height approx. 3.7 to 4.0 m
- power/data cabling via cavity floor or underfloor duct systems
- partial air-conditioning, ventilation, daylight-illuminated workplaces and occasional artificial lighting in inner zones

## 3 COMBI OFFICES

- room area 9 to 12 m<sup>2</sup>
- room depth approx. 4 to 5 m per room (with building depths 15 to 17 m<sup>2</sup>)
- room width approx. 2.3 to 3 m for standard workroom
- 1 to 2 employees per room
- storey height approx. 3.0 to 4.0 m
- offices accessed via communal zones
- power/data cabling via window ducts, cavity floor or underfloor duct systems
- window-ventilated rooms, poss. partially air-conditioned (generally cooled)
- daylight-illuminated workplaces with occasional artificial lighting
- workrooms arranged around an internal communal area

## 5 PRESTIGE OFFICES

- room area 25 to 100 m<sup>2</sup>
- room depth 5 to 10 m
- room width 5 to 10 m
- 1 employee per room
- storey height 2.5 to 4 m
- access via corridor or anteroom
- power/data cabling via cavity floor, underfloor duct systems and/or window duct
- window-ventilated rooms, poss. partially air-conditioned
- daylight-illuminated workplaces with occasional artificial lighting and additional accent lighting

## 6 CAD OFFICES

- room area 80 to 500 m<sup>2</sup>
- room depth 8 to 20 m
- room width 10 to 25 m
- 6 to 30 employees per room
- storey height 3.5 to 4.5 m
- non-corridor access to workplaces
- power/data cabling via cavity floor or underfloor duct systems
- partially air-conditioned, from 15 m room depth fully air-conditioned
- permanent artificial lighting with occasional reduced daylight

## 7 CONFERENCE/TRAINING ROOMS

- room area 50 to 400 m<sup>2</sup>
- room depth 5 to 15 m
- room width 8 to 20 m
- storey height 2.5 to 4.5 m
- power/data cabling via cavity floor or underfloor duct systems
- partially air-conditioned, poss. fully air-conditioned
- daylight-illuminated workplaces with occasional artificial lighting and supplementary lighting for multimedia presentations

## 8 OFFICES OPEN TO THE PUBLIC

- room area 100 to 800 m<sup>2</sup>
- room depth 10 to 20 m
- room width 10 to 40 m
- 6 to 40 employees per room
- storey height 3.5 to 4.5 m
- non-corridor systems for workplace access

# Office lighting

Types of lighting and lighting concepts

Lighting illuminates rooms and sets the scene for room use; the different types of lighting available provide the tools for doing this. Aside from meeting the requirements of technical and functional regulations, standards and guidelines, good lighting also creates an aesthetically pleasing environment, generates positive moods and promotes a sense of well-being.

The modern working world with its mobile teamwork, recreation zones and flat-screen monitors permits and requires new lighting solutions. Designing a lighting system for optimum functionality and aesthetic appeal calls for a knowledge of the different types of modern lighting available and the kind of impact they have.

Today, numerous luminaire systems with different lighting characteristics are available for providing good lighting in office and administrative buildings: from the traditional recessed luminaire for direct lighting through direct/indirect surface-mounted, pendant or standard luminaires for variable light distribution to computerised lighting systems.

Major advances in component design have brought about considerable improvements in all luminaire systems in recent years. New electronic ballasts and control systems, reflector materials and lamps make for higher luminous efficacy, precise optical control, better glare suppression and lower internal power losses. Greater cost-efficiency is achieved due to the higher light output ratios of modern types of lighting and marked improvements have been made in convenience and safety.

Selecting the right type of lighting entails striking the right balance between visual performance, visual comfort and visual ambience. It also means meeting the requirements of the technical and statutory regulations governing the lighting levels, harmonious brightness distribution,

**B1, B2, B3 and B4**  
4 types of lighting for office space and office workplaces

**Z1, Z2, Z3 and Z4**  
4 types of lighting for illuminating vertical surfaces – especially those of cabinets and shelving systems – and communication zones.

direct and reflected glare limitation, direction of light, modelling, light colour and colour rendering required for the relevant office activity.

For office lighting applications, there are three lighting concepts. These concepts can be realised by lighting types B1, B2, B3, B4, Z1, Z2, Z3 and Z4. The table on page 7 shows the types of lighting recommended – B1 to B4 – for each lighting concept. Additional recommendations for lighting types Z1 to Z4 are shown in a matrix on the pages devoted to the individual types of office.

Designing a lighting system calls for detailed specialist knowledge. The expertise and experience of lighting designers and lighting engineers are essential for good results.

More information about the components of the different types of lighting is provided on pages 38 to 46 of this booklet.

**3 lighting concepts**  
for offices:  
room-related ■  
task area ■  
work surface ■  
lighting

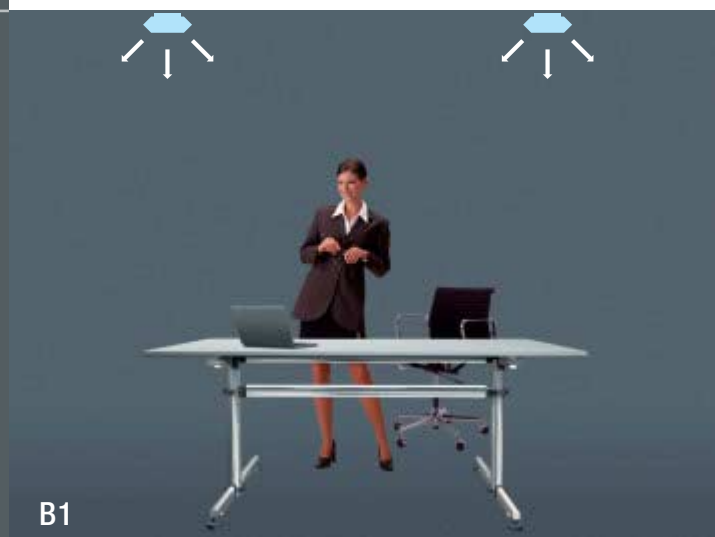

**B1**  
Direct lighting  
(ceiling luminaires)



**B3**  
Task lighting with special optical control  
(pendant luminaires)

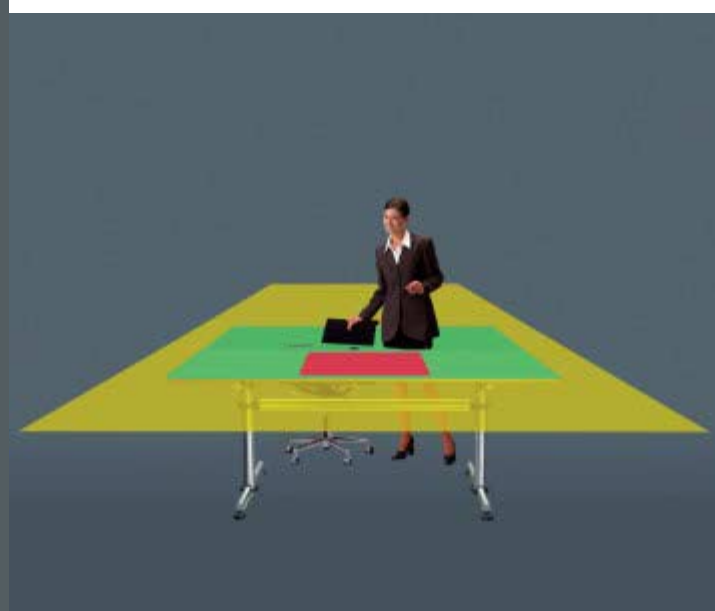





B2

**Direct/indirect lighting**  
(pendant luminaires)



Z1

**Spot** for illuminating vertical surfaces



Z2

**Wallwasher** for illuminating vertical surfaces



B4

**Indirect lighting with direct workplace lighting**  
(standard and desktop luminaires)

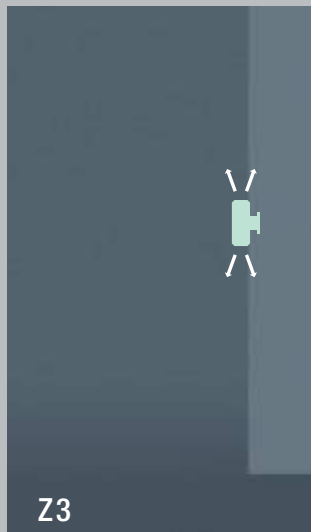

Z3

**Wall luminaires**  
for illuminating walls



Z4

**Downlights** for illuminating communication zones

## Lighting concepts

## Types of lighting

### Room-related lighting

Uniform lighting throughout the room creating roughly the same visual conditions at all points. This is recommended where the arrangement of task areas is unknown during the planning phase or where the arrangement of task areas needs to be flexible.

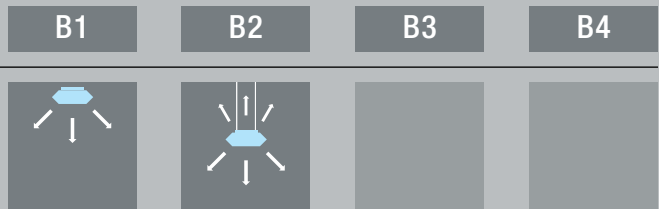

### Task area lighting

Different lighting for task areas and the space around them. This is recommended where a room contains several task areas which are used to address different visual tasks and thus have different lighting requirements. It is also an option where visual divisions are needed to identify different workplace clusters.

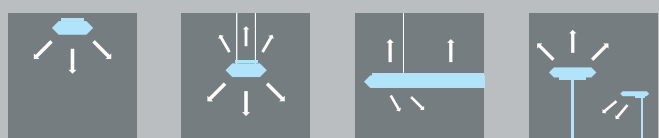

### Work surface lighting

Workplace luminaires can be used to supplement "basic lighting" – which can be either room-related or task area lighting – to achieve a level of lighting finely tuned to the requirements of the visual task or to personal needs. DIN 5035-8 sets out requirements/recommendations for workplace luminaires.

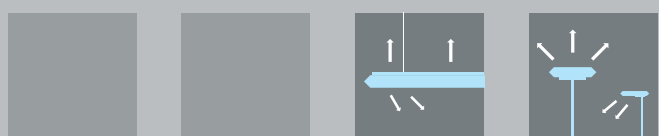

## Cellular offices

The cellular office is the type of office traditionally used to accommodate a maximum of six office workers – and it is still the best solution for personnel who predominantly perform tasks which require concentration, a personal archive of files and books or the privacy needed for confidential conversations with clients or staff. It is also ideal for small groups of two to three people who work together as a team and constantly need to exchange information about their work.

Despite its structural limitations, the cellular office is very popular with most office workers. For many, the high degree of privacy, the proximity of windows and the possibility of tailoring the room, its climate and its lighting to personal tastes outweigh the disadvantages. The lack of interaction with a larger group needs to be made up in other ways here, e.g. in meetings.

Cellular offices are put to many different uses. They accommodate scientists and section leaders, secretaries and designers; they are used for VDU work and team meetings, concentrated study and appointments with clients. The diversity of room use is reflected accordingly in a wide range of room shapes, furnishings, colour schemes, etc.

The type of lighting required depends on the structure of the room, the use or uses to which it is put and the atmosphere that needs to be created. In most cellular offices, louvered recessed luminaires are the option most widely preferred. Louvered luminaires suitably glare-suppressed for direct lighting are an economical solution for many applications, also providing good conditions for VDU work.

A more agreeable and more motivating impression is made by a room where pendant luminaires for direct/in-

direct lighting are used. By illuminating the ceiling, these avoid a “cave effect” even in small offices, achieve a more natural distribution of brightness and give the room a more homely appearance. For meetings especially, direct/indirect lighting systems generate a better visual ambience because light and shade are more balanced and faces look more natural.

Standard luminaires add a prestigious note to cellular offices. As direct/indirect lighting systems, they offer all the advantages mentioned above but can additionally enhance the room architecture through their design. In conjunction with desktop luminaires, the room and the work surface on the desk are equally well illuminated. Another important advantage is flexibility, because even today one in four company employees changes offices at least once a year. A lighting system consisting of standard and desktop luminaires can move with a relocating employee without ceiling and electrical installations having to be touched.

For vertical surfaces where reading tasks are performed, e.g. at cabinets, shelving systems, wall charts, maps, supplementary lighting is needed.

Even though light switches are normally within easy reach in cellular offices, lighting control systems have distinct advantages. Conferences and group communication often take place outside the cellular office, which then stands empty, so presence-dependent control is a practical and convenient addition to the lighting system. Other economic and logistical advantages are provided by central control systems which check if office lights have been switched off in the evening and whether lamps need to be replaced.

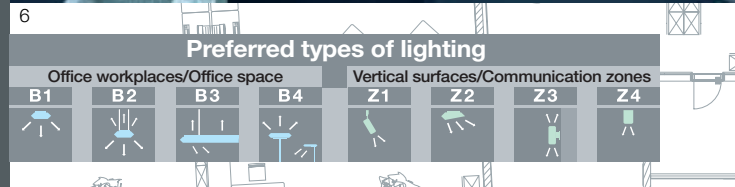



FGL-3D-VISUALISATION®

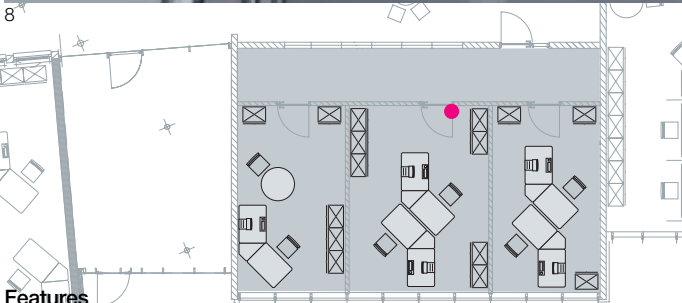

**Features**

- Standard cellular office (fixed room structures) and superior cellular office (flexible repositionable walls, higher costs for requisite flexibility of façade, interior work and building systems)
- 1-person room for work requiring intense concentration behind a closed door
- 2 to 3-person room for intensive cooperation and communication within a very small unit
- Multi-person room for intensive cooperation and communication in a team or small unit
- Prestige 1-person office with interview facilities for corporate executive



## Group offices

The group office emerged as an initial response to the new forms of work that heralded the age of communication. It made its appearance in the late 1970s and early 1980s when offices started to become computerised and office work was transformed as a result. The rigid departmental groupings of the open plan office were replaced by smaller units which could work more closely and effectively as teams.

In the 1990s, architects looked at the down-scaled open plan offices again and developed new ideas for group or team offices. Monotonous arrangements of desks designed solely to make efficient use of space were superseded by zonal concepts.

Owing to its comfortable size, flexible design and effective communication structure, the group office is still a popular office and work concept even today. It avoids the anonymity of the open plan office and provides good conditions for direct personal teamwork in established groups of 8 to 25 employees.

One central issue in the context of group office lighting is daylight control. Where rooms are seven to eight metres deep, special light-reflecting window blinds can usefully direct available daylight to the parts of the room farthest from windows.

But adequate daylight is not always available, so workplaces located deep in the room still need to be illuminated by artificial light sources. In the classic set-up, desks are positioned one behind the other at right angles to the window wall. Daylight then falls on desktops and workstations from the side, with window glare eliminated by blinds. The artificial lighting units – e.g. louvered luminaires for direct lighting – are mounted parallel to the

window wall to provide effective task area illumination.

Other lighting concepts permit a free and flexible arrangement of workplaces. For workplace clusters – i.e. relatively small groups of desks – pendant luminaires for direct/indirect lighting generally yield better results. Owing to the brightness of the ceiling, the lighting looks more natural, dazzling reflections on work materials and screen are reduced, and the better modelling makes faces and objects look more appealing. For a more flexible workplace arrangement, direct/indirect standard luminaires can be used in combination with desktop luminaires. Vertical surfaces where reading tasks are performed – at cabinets, shelving systems, wall charts, maps, etc. – call for adequate supplementary lighting.

To give a group office an energising, motivating atmosphere without compromising on clarity of structure, the lighting should emphasise the zonal layout of the room. Downlights, for example, can be used to provide agreeable, non-directional lighting for service centres, where documents are faxed or copied. Where these facilities are located at the perimeter of the room, indirect wall luminaires are another option. In conference zones, direct/indirect luminaires should be used wherever possible to ensure natural modelling for faces and work materials. In regeneration zones, light colours should be warm, e.g. provided by luminaires in an indirect trunking system supplemented by table luminaires for reading tasks.



10



11



FGL-3D-VISUALISATION®

12

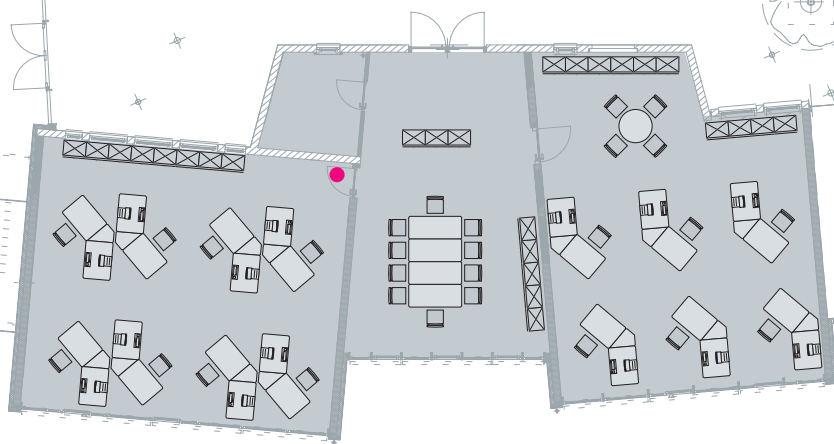

13

**Features**

- Enclosed open-plan group rooms with few room-dividing elements (screen or cabinet partitions) or rooms with a combination of open and closed structures defined by room-dividing systems (room-in-room systems) or elements.
- Open office space with open group zones which can be separated from one another – e.g. by assignment to different levels – yet which still permit inter-zonal visual communication and generate a sense of security through their architecture and workplace clusters.

Preferred types of lighting							
Office workplaces/Office space				Vertical surfaces/Communication zones			
B1	B2	B3	B4	Z1	Z2	Z3	Z4

## Combi offices

In the office buildings of the information society, the efficiency and success of employees depends to a large extent on communication. In many cases, employees work on successive projects in a team, with each team member addressing a special assignment relating to the project. The concentrated work of the individual is thus performed in constant consultation with the team.

The combi office is an architectural response to this way of working. It permits a connection between the open communication of the team and the individual work of the team members. The combi office thus combines team spirit and communication, transparency and flexibility.

Structurally, a combi office is like a marketplace: a communal space surrounded by individual "houses". A marketplace provides a platform for the public exchange of information and trade in goods. The houses around it are where the information is processed and the products manufactured.

In the same way, the individual workrooms of a combi office can also be seen as production sites. They are where parts of the project are crafted in concentrated individual work. The fruit of that labour is taken to the adjacent communal zone, where the various parts of the project are put together by the team. But the communal zone performs other vital functions as well. It is both a communication and a supply centre – accommodating not just the zones for team meetings but also photocopiers and fax machines, files, records and shared information resources, such as periodicals and reference works.

Lighting for a combi office should also be modelled on the concept of the marketplace and provide zonal lighting wired for individual control.

In the workrooms in particular, it must be remembered that "production work" is very diverse, ranging from reading project papers to performing graphic design work at a VDU, to holding small informal meetings at the workplace.

A bright, agreeable atmosphere is created by direct/indirect pendant luminaires or standard luminaires. Dimmable luminaires, supplemented by desktop luminaires at the workplace, permit individual lighting scenes. As most offices have relatively large windows, the use of lighting control systems permitting daylight-dependent regulation of the general lighting is recommended.

For vertical surfaces where reading tasks are performed – e.g. at cabinets, shelving systems, wall charts and maps – adequate supplementary lighting is required.

In the communal room, the lighting should be designed to enhance spatial clarity by differentiating between zones. This helps identify the various function zones of the "marketplace" and enables lighting to be tailored to the relevant visual tasks.

Direct/indirect pendant luminaires over conference zones create an agreeable ambience in which faces and work materials can be clearly identified. For temporary workplaces and reading areas in the communal room, direct/indirect standard luminaires – possibly regulable models – are a flexible solution. For optical emphasis and differentiation of the individual zones, downlights are a suitable choice. They also provide effective guidance through the room.

For the general lighting in the communal room, economical louvered luminaires with good glare suppression offer a high degree of visual comfort.

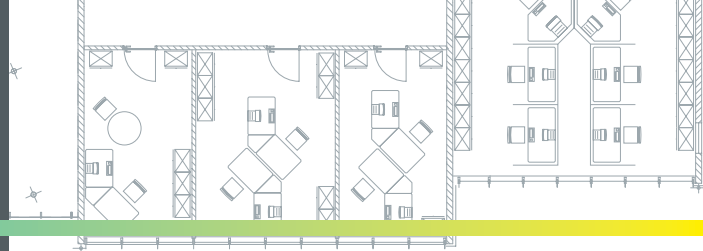

14

### Preferred types of lighting

Office workplaces/Office space				Vertical surfaces/Communication zones			
B1	B2	B3	B4	Z1	Z2	Z3	Z4



15



16

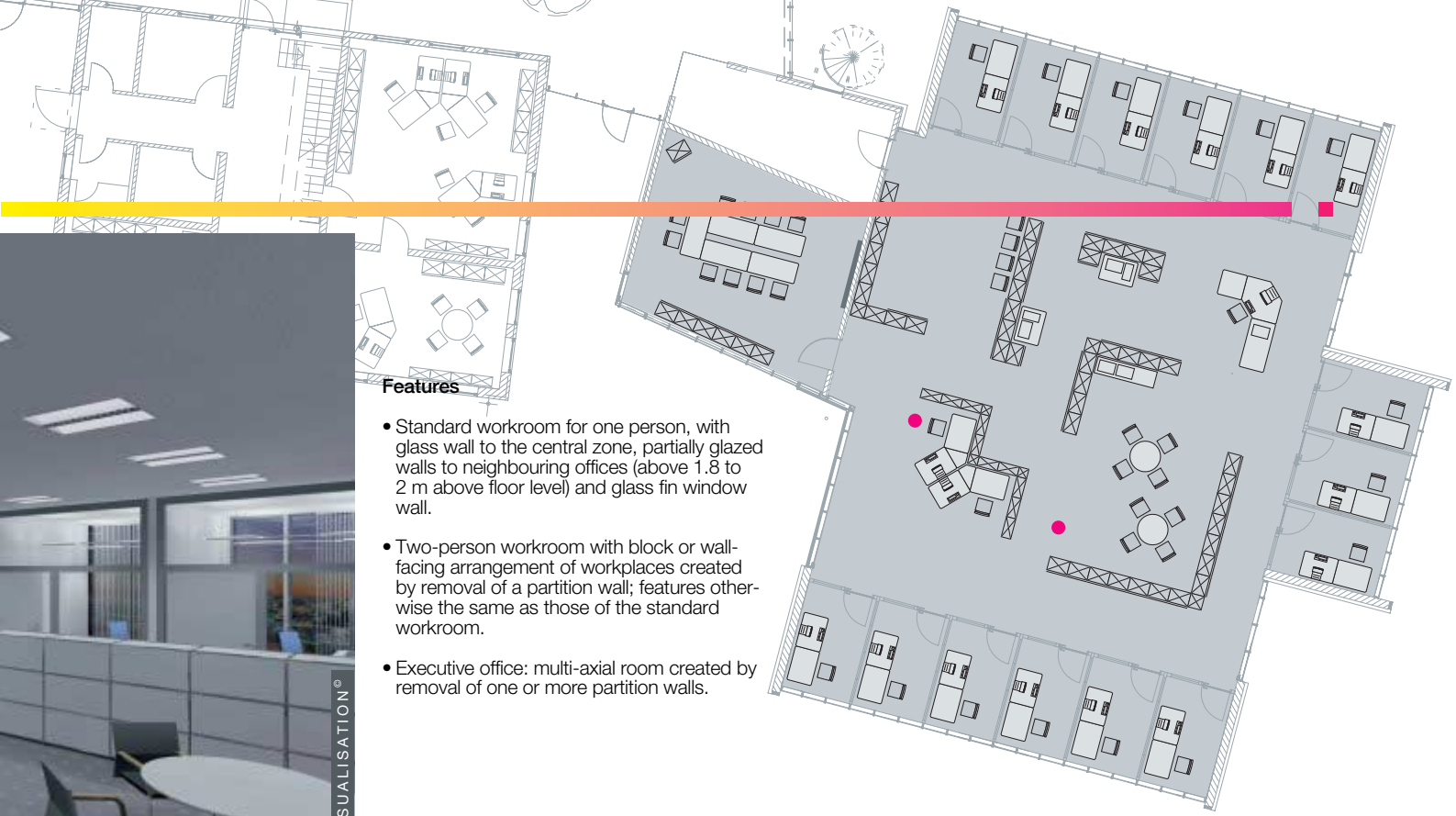

**Features**

- Standard workroom for one person, with glass wall to the central zone, partially glazed walls to neighbouring offices (above 1.8 to 2 m above floor level) and glass fin window wall.
- Two-person workroom with block or wall-facing arrangement of workplaces created by removal of a partition wall; features otherwise the same as those of the standard workroom.
- Executive office: multi-axial room created by removal of one or more partition walls.



FGL-3D-VISUALISATION®



FGL-3D-VISUALISATION®

17



18



13

## Open plan offices

For quite some time, open plan offices have been experiencing a renaissance. The functional and flexible structuring they permit makes them an attractive option for many company operations where efficient room use is a must. Their popularity has been boosted, in particular, by the rapid spread of call centres. Nearly 200,000 people in Germany work in this sector alone.

Modern open plan offices are still very much geared to VDU work; most of the activities performed in them consist of computerised tasks requiring concentration. Communication in an open plan office is mostly telecommunication, i.e. telephone communication with customers or outfield colleagues.

In today's open plan offices, one finds many "clusters" of workplaces, where teams work together. Workplace arrangements here can vary considerably, from strict geometrical patterns to circular office landscapes.

With computer workplaces, it is essential to ensure that the strain on the eyes from switching constantly back and forth between screen, work materials and surroundings is kept to a minimum and that the need for strenuous accommodation and adaptation is avoided. So monitors and any papers the operator needs to consult should be the same distance from the eye, 40 to 80 cm.

It is also important to avoid direct and reflected glare. Direct glare occurs as a result of excessively high luminance contrast, e.g. where a VDU is positioned directly in front of a window. Reflected glare results from bright surfaces, such as windows or luminaires, being reflected on screens.

Where these sources of disturbance are not adequately limited, fatigue, underperformance and personnel health problems result. It is important, therefore, that VDUs should be arranged in relation to windows or shielded by curtains or blinds in such a way that glare is avoided. Room-dividers or cabinet partitions can help make glare suppression measures more effective.

For the lighting designer, this means meeting a number of specific requirements. First, account needs to be taken of the insular character of the team clusters. A variety of modern direct/indirect pendant luminaires specially developed for VDU work are available for workgroup lighting in open plan offices. For vertical surfaces where reading tasks are performed, e.g. at cabinets, shelving systems, wall charts or maps, adequate supplementary lighting is required.

The challenge does not end with work zone lighting, however. Communication and perimeter zones also require attention. Conference and reception zones lend structure to the room and call for varied lighting to emphasise their special character and facilitate orientation in the room as a whole. Bright perimeter zones, e.g. walls illuminated by wallwashers, make the room look larger.

In open plan offices in particular, user comfort can be significantly enhanced by lighting control systems. And as such offices frequently have long rows of windows, considerable room depths and various types of lighting, daylight-dependent regulation of window blinds and individual room lighting elements may also be considered.



19







### Features

- Large office unit with mostly open workplace structure and few subdividing partitions and cabinets. Pronounced hierarchical layout: prestige offices near windows, preferably in corners of the room (corner offices).
- Office landscape with various team zone clusters with variable arrangements of partitions. More private areas for managerial workplaces. Integrated conference, technical and regeneration zones.
- Room-in-room systems with the high degree of flexibility needed to cater to different organisational and staff requirements.



FGL-3D-VISUALISATION®

20

### Preferred types of lighting

Office workplaces/Office space				Vertical surfaces/Communication zones			
B1	B2	B3	B4	Z1	Z2	Z3	Z4



21

15

## Prestige offices

**A**s the name indicates, a prestige office underlines the stature of the company and the individual to whom it is assigned. Its interior design should reflect the identity of the company or the personality of the occupant. This is where prestige offices get their atmosphere, which can range from cool and businesslike to light and experimental, to uncompromisingly sumptuous.

Most prestige offices consist of three zones, each with a clear purpose: first the workplace, where a variety of tasks are performed and VDU work plays only a minor role; secondly a conference zone, designed to cater for small group meetings; and thirdly a “presentation zone”, where the company presents its corporate culture and its work.

The three room zones share a uniform atmosphere, although each zone has its own function and mood. The atmosphere needs to be appropriate for the statement which the room is supposed to make; in most cases, a cheerful homely atmosphere is required. In offices with a relatively dark colour scheme and lots of wood finishes, this is best supported by soft indirect lighting and warm light colours.

At the workplace, there is normally no need for purely functional lighting. On the contrary, the lighting should be part of the architecture and designed to cater for a variety of visual tasks. Standard and desktop luminaires or pendant luminaires of decorative, futuristic or purist design are suitable options. What is important is that the lighting is bright enough for all visual tasks, glare due to windows and luminaires is avoided and the distribution of light at the workplace and throughout the room is harmonious. Marked differences in brightness along different lines of sight make it harder for the eye to adapt and give rise to fatigue.

For vertical surfaces where reading tasks are performed – e.g. at cabinets, shelving systems, wall charts or maps – adequate supplementary lighting is required.

In the conference zone, lighting should be low-key to permit full concentration on the persons present. Balanced modelling and warm light colours help give faces a more natural and agreeable appearance. Direct/indirect luminaires fitted with warm-tone lamps provide the high vertical illuminance required and cast a soft, pleasant light. Glare due to direct lighting or reflections needs to be avoided, as does a marked contrast in brightness with the surroundings. Both are distracting and cause visual fatigue; concentration and motivation suffer.

In the third room zone, the presentation zone, attention needs to be directed to objects or images. At the same time, the presentation zone must be neither too bright nor too dark in relation to the rest of the room; direction of light and modelling must be designed to ensure that three-dimensional objects are identifiable as such. Downlights, wallwashers and a variety of spots can be an effective accentuating lighting solution here.

In view of the many different types of lighting used in most prestige offices, a programmable lighting control system makes good sense. Pre-defined lighting scenes for concentrated work at the desk, meetings with colleagues or the reception of guests help ensure balanced lighting in the room and permit a comfortable lighting atmosphere for the situation required.



22



23

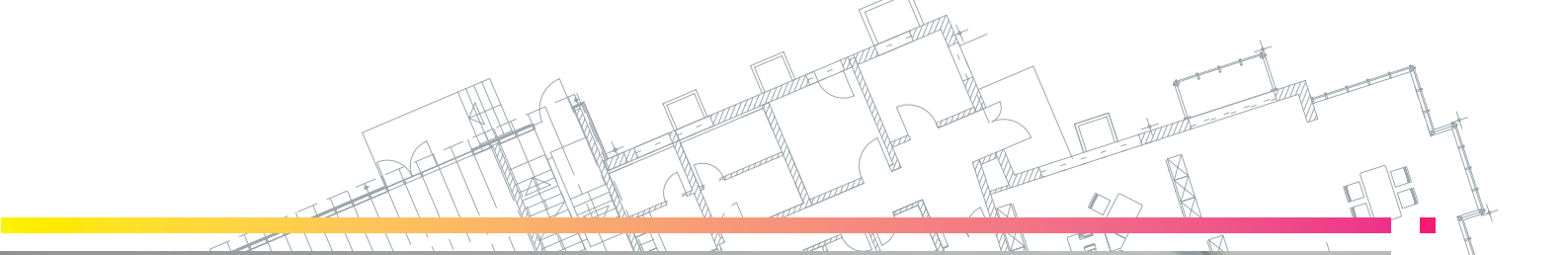

FGL-3D-VISUALISATION®

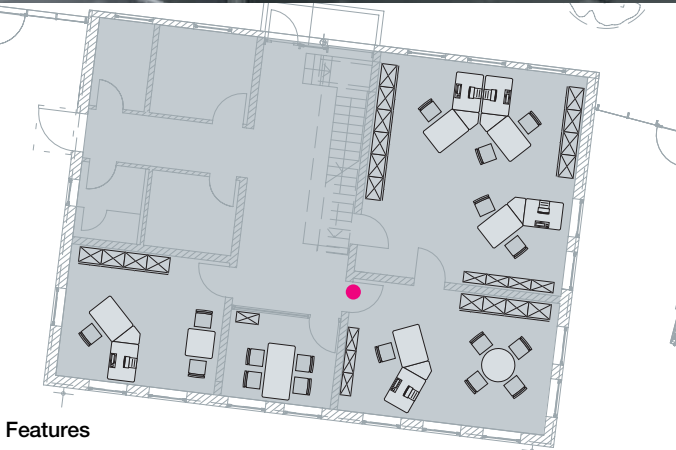

**Features**

- Multi-axial room with very open room structure, little or no subdivision by room partitioning systems
- Open conference zone distinguished from the workplace by its interior and lighting design
- Direct connection to adjoining conference rooms or secretarial offices

Office workplaces/Office space				Vertical surfaces/Communication zones			
B1	B2	B3	B4	Z1	Z2	Z3	Z4



From a lighting viewpoint, computer-aided design is one of the most demanding office activities of all. Characters and symbols, super-fine lines and patches of varying contrast and colour call for intense concentration and perfect visual clarity of screen displays, work materials and other objects. So special attention needs to be paid in CAD offices to ergonomic workplace design.

Room and workplace lighting plays an important role in ergonomic design. Lighting levels need to be chosen to ensure a balance between the brightness of VDU screen, task area and surroundings. Changing visual tasks – i.e. working on screen, executing sketches on light-coloured paper and making visual contact with colleagues in the room – call for harmonious luminance distribution.

Direct and reflected glare needs to be limited. Direct glare is caused by bright surfaces, such as windows, or unshielded lamps; reflected glare is caused by light reflections on glossy paper or screens. Direct and reflected glare cause extreme differences in luminance and impair visual conditions, thus undermining office workers' sense of well-being and ability to concentrate on the task in hand.

To ensure good visual performance, a classic arrangement of workplaces at right angles to the window wall is recommended, with desks for ancillary design operations positioned near the window and CAD workstations located nearer the middle of the room. Daylight then falls on desks from the side and glare is largely eliminated. Luminaires should be installed parallel to the window wall. High-grade specular louver luminaires with specially designed louvers ensure glare-free lighting at the workplace.

Adequate daylight is not always available, so luminaires should be positioned to the left and right of the desks. The direction of light and modelling thus achieved permits paperwork and objects to be viewed without undue risk of fatigue.

As for types of lighting, direct/indirect luminaires offer the highest degree of comfort. A bright ceiling makes for balanced luminance distribution, giving the room lighting a more natural and more motivating impact. Supplementary desktop luminaires enable the lighting to be tailored to individual work situations. In aisles, louvered luminaires, downlights or direct/indirect wall luminaires are a suitable option.

What is particularly important in CAD offices is modern lighting control. For one thing, the lighting level at each individual workplace needs to be adjustable for different tasks because while a great deal of light is needed for studying technical drawings on paper, VDU work often calls for dimming. Secondly, uniformity of lighting needs to be right at all times of day. Where incident daylight at desks is intense, both the German national ordinance protecting employees working at VDUs and EU Directive 90/270 stipulate that window-blinds must be provided for screening and supplemented, if necessary, by artificial lighting.

For vertical surfaces where reading tasks are performed – e.g. at cabinets, shelving systems, wall charts or maps – adequate supplementary lighting is required.



26



27



28



**Features**

- Large office unit with mostly open workplace structure and few subdividing partitions and cabinets.
- Screened areas for integrated conference and technical zones

**Preferred types of lighting**

Office workplaces/Office space				Vertical surfaces/Communication zones			
B1	B2	B3	B4	Z1	Z2	Z3	Z4



## Conference rooms / training rooms / video-conference rooms

**M**ultifunctional presentation rooms play a central role in many companies. They are used to receive visitors, address clients and staff and provide a place where colleagues can confer amongst themselves. They need to reflect the company's image and corporate culture, promote lively discussion and in-depth consultation and provide access to multimedia facilities.

So these rooms need to perform a wide variety of functions and create a wide variety of moods. Receptions for clients, for example, call for an air of openness, whereas intensive consultation requires a more secluded atmosphere. So the prime requirement that conference and training rooms need to meet is flexibility of room use – something which is achieved by a variable room layout created by movable partitions and versatile furniture. This variability needs to be reflected by the lighting, which must also be able to cater for different functions and create different moods.

Attaining this goal calls for a differentiated lighting design permitting a variety of lighting scenes. For the general lighting, two basic scenes are particularly important: a bright, illuminated ceiling coupled with harmonious brightness distribution for conveying an impression of openness in the room, and highly accentuating lighting in certain zones for conveying an impression of seclusion.

For the first lighting scene, direct/indirect pendant luminaires can make for balanced room lighting with an agreeable basic brightness. For the second, the "private" lighting atmosphere required can be provided by downlights or by spots mounted on power track. Vertical surfaces where reading tasks are performed – at cabinets, shelving systems, wall charts, maps, etc. – call for adequate supplementary lighting.

Many mood variants can be achieved for multifunctional rooms by combining different lighting systems, e.g. pendant luminaires with downlights or recessed or surface-mounted ceiling luminaires with power track and spots.

General lighting must always be supplemented by accent lighting because certain room zones require different illumination, depending on the use to which they are put. For presentations, accent lighting provides the vertical illumination needed at rostrum or stage to cast speakers in the right light; for video-conferences or beamer presentations, it ensures basic lighting for safety in the room and smoothes out extreme differences in luminance. For the audience, safe glare-free orientation in the room must be guaranteed at all times.

The bandwidth of options for accentuating lighting is extremely wide: it ranges from downlight wallwashers and power track spots for illuminating rostrums and walls to decorative recessed wall luminaires and recessed floor luminaires. What is very important for accent lighting is a balance between functionality and creativity. The character of the room should be underlined and the architecture or selected room zones emphasised. Variations in the luminaires used, different light colours and switches from wide to narrow-beam luminaires offer many opportunities to inject life into the room through lighting.

Using differentiated lighting like this in practice calls for modern lighting control. Where several lighting systems are present and multiple room users involved, the lighting needs to be programmable, enabling a predefined lighting scene to be activated when a particular lighting atmosphere is required. This is the only way the lighting designer can craft the right light to make the right statement for receptions and presentations, training sessions and conferences.

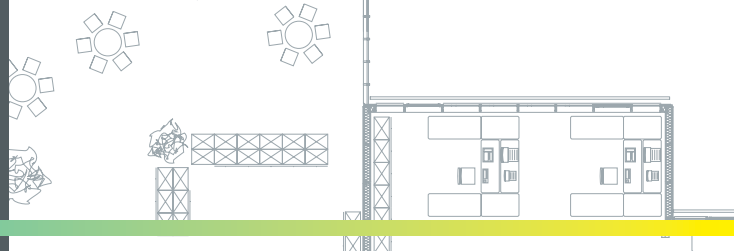

30

Preferred types of lighting							
Office workplaces/Office space				Vertical surfaces/Communication zones			
B1	B2	B3	B4	Z1	Z2	Z3	Z4



31

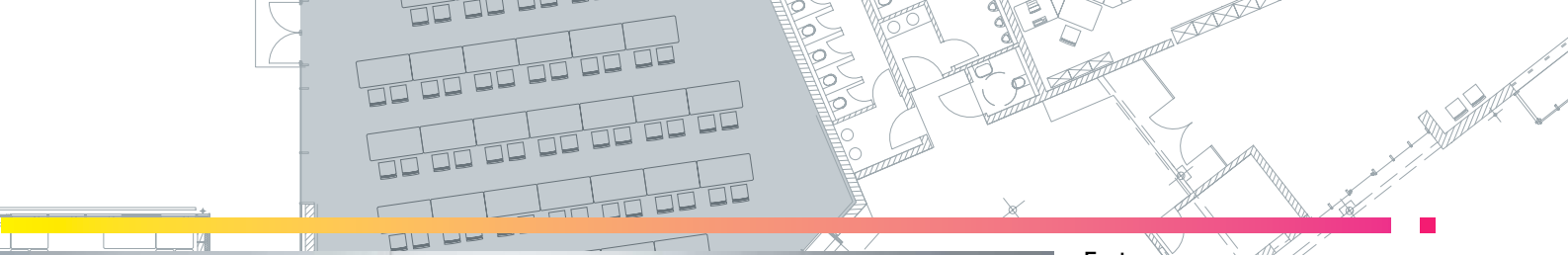

**Features**  
**Video-conference room**

- Multi-axial room with very open room structure, no subdivision by room partitioning systems.
- Open hall, no subdivision or flexible subdivision by means of partitions for room-in-room systems
- Variable arrangement of individual and team desks

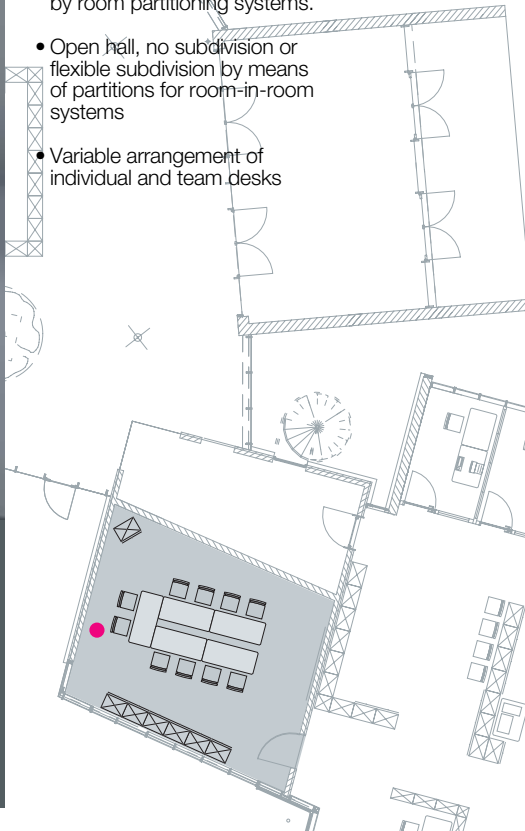

FGL-3D-VISUALISATION®

32



33



34

## Offices open to the public

Despite Internet and e-mail, personal contact is more important than ever for many companies and organisations today. Customers, clients and members of the public want personalised advice and wish to meet the people they deal with face to face. In much of the private sector, an invitation to visit the company in person is an important part of customer bonding and a good opportunity to promote image and product range.

Classic service halls, with their cold stone floors and high ceilings, are being relegated to the past. The preference today is for a more homely atmosphere, with warm colours, small room units and a consulting zone that has shifted from the counter to niches or desks.

As in all relatively large interiors, the lighting concept here needs to reflect the structure of the room, with its various zones for different tasks. Visitors entering the room want to be able to identify clearly where they need to go. Bright reception areas and illuminated information panels facilitate initial orientation and direct visitors' attention.

To avoid cave effects in an entrance area, room lighting and ceiling illumination need to be adequately bright. An interesting effect is achieved with louvered luminaires or downlights in the ceiling and indirect ceiling floodlights mounted on walls or pillars. Large luminous ceilings or direct/indirect pendant luminaires also create an agreeable and natural atmosphere.

In interview niches and at consultants' desks, the lighting needs to be suitable for both communication situations and VDU work. Where room layouts frequently change, the lighting needs to be equally flexible. Desktop luminaires and standard luminaires for direct/indirect lighting can be repositioned at any time and, where ceilings are bright and a normal height, create lighting conditions which permit high visual comfort for interviews and good visual performance for VDU work.

For vertical surfaces where reading tasks are performed – at cabinets, shelving systems, wall charts, maps, etc. – adequate supplementary lighting is required.

Offices which are open to the public also perform a representative function, so attention needs to be paid not only to the functional design of the lighting but also to its visual appeal and aesthetic impact. Even with the most impressive architecture, however, that impact can only be achieved if the right light is provided at the right place. Recessed floor luminaires and downlights vividly emphasise pillars; spots cast selected zones in a dramatic light or imbue presentation areas for images and artworks with visual tension. For the public, good and exciting lighting design brings a room and its architecture to life.



35



36







37/38

### Features

- Multi-axial room with open room structure, little subdivision by room partitioning systems
- Large open room subdivided by partitions or cabinet systems into consulting, technical and workplace zones.

### Preferred types of lighting

Office workplaces/Office space				Vertical surfaces/Communication zones			
B1	B2	B3	B4	Z1	Z2	Z3	Z4



FGL-3D-VISUALISATION®

## Reception rooms / reception areas

**E**ntrance areas make a first and crucial impression on visitors. Architecture and dimensions, materials and furniture, lighting and acoustics – they all combine to form an “image” the moment the visitor enters the room. For every visitor, the entrance area is the point of initial contact, the beginning of all communication with their host.

Entrance areas generally consist of four zones: the actual entrance, the reception area, the lobby and the areas leading into the building. So the primary task for architect and lighting designer is to identify these zones and provide clear aids to orientation for the visitor.

The entrance links the outdoor areas with the interior of the building. This is where the visitor steps out of the daylight into the building. As the human eye takes time to adapt from the bright daylight outdoors to the lower lighting indoors, entrances need to be particularly bright. Adaptation is facilitated by large windows and glare-free lighting of high luminous intensity in this area. A daylight-dependent lighting control system should adjust the artificial lighting in line with the level of available daylight. Steps or stairs in this area need to be particularly well identified and illuminated.

Most visitors first make their way to the reception desk, so this needs to be clearly identifiable as such. Supplementary lighting provided for a reception area and any vertical information panels makes these stand out against the surroundings and helps visitors find their way. A cheerful, inviting atmosphere is generated by harmonious brightness distribution with anti-glare lighting for counters and signs as well as warm light colours.

The lobby area is a place for communication, a place where visitors are greeted. The purpose of lighting here is to create a visual ambience where people – and especially people’s faces – can be clearly recognised. Highly directional lighting should be avoided because it casts unfavourable shadows. Direct/indirect lighting with warm light colours ensures a balanced distribution of light and helps create a positive atmosphere for communication.

Corridors, staircases or lifts connect the entrance area with the interior of the building. Here, too, lighting can facilitate visitor orientation, e.g. in route guidance systems incorporating coloured LED luminaires. A clear light guidance system points visitors in the right direction and bright display panels or backlit signs provide information.

Corridors and staircases can appear intimidating if they are much darker than the entrance area. To avoid this tunnel effect, care must be taken to ensure uniform or gradually decreasing brightness.

For staircases especially, glare-free lighting is essential on the stairs. Safety can be heightened by modern LED modules integrated into the stairs or recessed wall luminaires illuminating the treads.

In entrance areas with large windows, a daylight-dependent lighting control system for the artificial lighting is a sound proposition, as are optical control blinds designed to direct daylight deep into the room. Both systems make the lighting more attractive, heighten user comfort and improve the economy of the entire system.

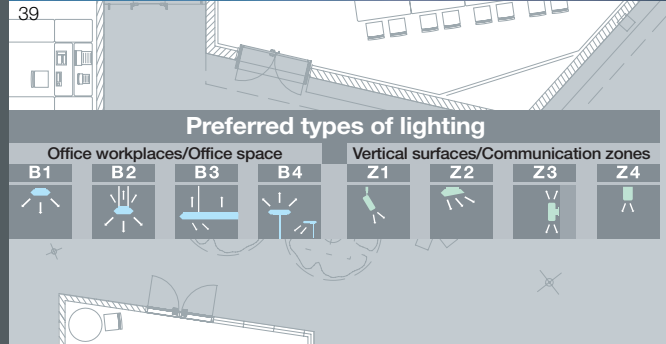
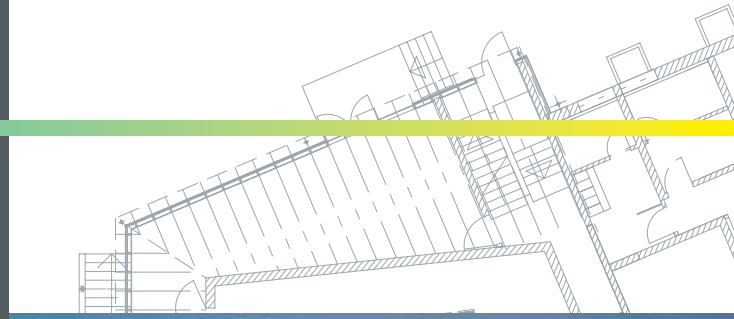

40



41

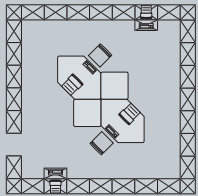

42



43



44

25

## Cafeterias / staff restaurants / rest rooms / communication zones

A new office culture is transforming the traditional structures of our working world. Work today is seen as an efficient team-oriented communication and information process, which includes informal meetings over breakfast, team talks over lunch and occasional spells listening to soothing music in a recreation zone. Work is part of life and life's experiences.

Cafeterias, staff restaurants and rest zones play an important role in modern companies. The works canteen for blue-collar workers with a separate section for management has largely disappeared. Today, comfortable catering areas or bistro tables are available for consultations between colleagues; armchairs with reading matter invite staff to switch off and unwind.

The point of these "task areas" is to give employees a sense of well-being. Modern companies long ago realised that contented staff work much more efficiently and feel more committed to the company than employees who are dissatisfied. The challenge for architect and lighting designer is to create the atmosphere needed to attain that goal of "well-being".

The architecture of modern catering and regeneration zones has become more "homely". Smaller rooms make for more intimate surroundings, lots of wood and warm colours create an agreeable atmosphere. The interior design is modelled on that of fine restaurants and bistros.

For the lighting designer, there is lots of scope for creativity here. Various types of lighting are available for crafting decorative lighting systems and lighting landscapes with atmosphere and emotional appeal. Modern lamps such as high-voltage tungsten-halogen lamps, low-voltage tungsten-halogen lamps with cool beam specular reflector

or new discharge lamps cast a brilliant warm light. Used in conjunction with small luminaires, they can make for discreet, design-driven lighting systems which integrate smoothly into the architecture of the room.

Whether the luminaires of choice for providing agreeable catering zone lighting are mini-spots, swivellable downlights or decorative pendant luminaires, the important thing is that light must be provided at the right place. Glare from unshielded general-diffuse lamps in lines of sight or disturbing reflections on shiny tabletops need to be avoided. Faces must be identifiable without excessive modelling and the colours of food and drinks need to be natural. For anyone looking across or around the room, differences in luminance levels should not be marked.

Food presentation areas, e.g. buffets, should be brighter than the rest of the room to make them stand out from the surroundings. Lamps should be selected for low heat generation and good colour rendering properties, so compact fluorescent lamps, for example, are a good choice. Good glare suppression is also a vital feature for luminaires used here.

In rest zones, lighting needs to be dimmable to meet different requirements. Lighting systems must also be flexible and, if possible, non-directional so that any changes in the room can be accommodated without major modifications to the lighting. For reading and conversation, suitable lighting can be provided by direct/indirect table luminaires beside armchairs. They should be dimmable and, if possible, permit adjustment of the way they distribute their light: for reading, most of the lighting in the seating area should normally be direct; for conversation, a bright room and more indirect lighting are required.



45



46



47



48



49

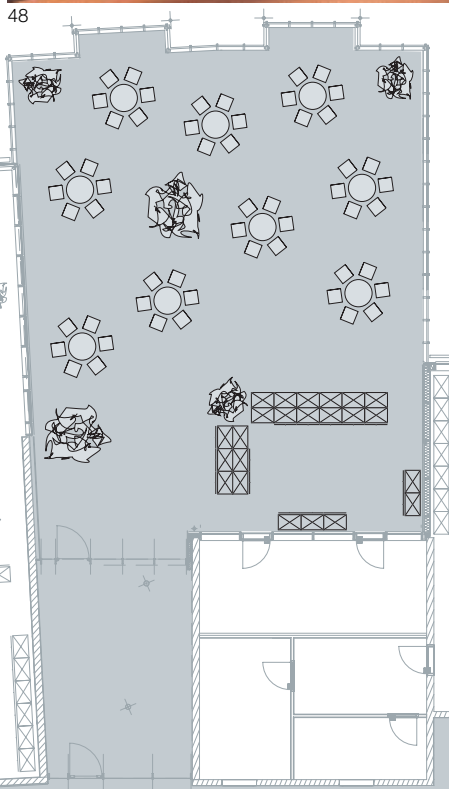

50



51

27

**Preferred types of lighting**

Office workplaces/Office space				Vertical surfaces/Communication zones			
B1	B2	B3	B4	Z1	Z2	Z3	Z4

## Outdoor areas / façades

The visual impact of a company building plays a signal role in corporate culture. The façade of a headquarter building makes a crucial first impression on visitors and generally appears on or near the front of image brochures. The emotional impact of a building exterior can range from inviting to intimidating, the difference often depending on nuances in proportions or lighting at night.

In recent years, the illumination of buildings for aesthetic reasons has become a major element of urban design. The artificial lighting of administrative buildings, fountains and bridges is increasingly used to make the face of a town or city more attractive and offer bright cheerful surroundings for people shopping or taking a stroll in the evening.

One of the first things that needs to be decided when designing exterior lighting for a building is light colour. The white light generally emitted by fluorescent lamps is suitable for modern architecture with clear contours. Luminaires with tungsten-halogen lamps or high-pressure sodium vapour lamps have a warmer light colour more appropriate for classical architecture with stucco ornamentation. To achieve the desired effect and not overload the façade and its surroundings, combinations of different light colours need to be precisely planned.

For effective illumination of individual trees or groups of trees, high-pressure sodium vapour lamps are the preferred solution for trees with light-green leaves or needles whereas metal halide lamps are recommended for trees with dark or bluish-green foliage. This produces a particularly interesting multi-coloured effect.

One of the primary purposes of façade lighting is to emphasise architectural statement. Controlled use of light

and shade gives a building a vivid presence during the evening and at night. The contours and colours of a façade can be made to stand out by narrow- or wide-angled floods while details such as pillars or decorative elements can be emphasised by recessed ground luminaires and downlights.

The other prime task performed by exterior lighting is to facilitate orientation. Signs and car-parks, communication routes and staircases as well as the building entrance need to be clearly identified. All the relevant areas must also be adequately bright because dark patches and unlit corners give visitors a sense of insecurity. Good glare suppression for luminaires is particularly important for outdoor lighting.

Lighting should provide security, especially where there is a risk of accident. Bright, uniform lighting for car-parks affords protection for motorists and pedestrians alike. Decorative bollard luminaires form part of the external architecture and provide lighting for peripheral zones, paths and steps.

Interesting light effects, enhanced visual comfort and power savings can also be achieved in exterior lighting by the use of a lighting control system. Modern systems adjust the brightness of the lighting as daylight fades or deactivate individual groups of luminaires where paths and car-parks are not used at night or at weekends.

More information on this subject is provided in Booklet 16 "Urban image lighting" of the FGL series "Information on Lighting Applications". See also Page 49.



52



53



54



55



56

29

The right quality of lighting and visual design of the working environment are fundamental requirements for the efficient, fatigue-free performance of visual tasks. They also make for a sense of well-being and boost motivation. Quality of lighting is defined by a number of **quality features**. These must not be considered in isolation, however, because most of them interact with one another. Where no attention is paid to glare limitation, for example, a high lighting level can cause visual discomfort and give rise to annoying reflections on VDU screens.

But lighting quality features are not the only factors that need to be considered. Visual comfort and the visual ambience of a room depend on an adequate supply of daylight, the design and colour scheme of the interior and daylight-dependent control of the quantity (lighting level) and quality (light colour, uniformity) of the lighting. (57)

Fault-free, and fatigue-free performance of a visual task is crucially dependent on **lighting level**, which in turn is defined by **illuminance** (expressed in lux/lx). The higher the lighting level, the better the visual performance, i.e. the faster and more accurately we register visual information. The kind of illuminance levels found outdoors – where values range from 10,000 lux on a cloudy day to over 100,000 lux in bright sunshine – cannot be realised in a room. Studies show, however, that around 50% of respondents reckon that 500 lx illuminance is a good lighting level for reading. Having said that, the other 50% find it too low. (58)

For accurate identification of faces and other vertical surfaces and objects in a room, the relevant yardstick is cylindrical illuminance. (59)

In an office, the lighting level needs to allow us to read and make out information on both screen and paper without difficulty. It must also permit visual communication with people around us and the working environment and help promote a general sense of well-being, motivation and dynamism. This calls for a balanced **distribution of brightness** in the visual field, i.e. the surroundings of the actual visual task. Brightness distribution depends on the **uniformity** of illuminance – primarily on the vertical surfaces of walls, cabinets and partitions – as well as the reflectance of such surfaces and the **brightness** (luminance) of windows.

### Recommended reflectance in offices:

ceiling	0.7 to 0.9
walls	0.5 to 0.8
floor	0.2 to 0.4
work surfaces, furniture, equipment	0.2 to 0.7

The illuminance values recommended for various visual tasks are shown in the table on pages 36/37. The values stated are the minimum physiological requirements for a measure of visual satisfaction. Higher values are frequently preferred, however, especially by older people, because the average 60-year-old needs around “twice as much light” as a 20-year-old. Higher values are also found useful during the darker months of the year, when they help maintain concentration and motivation.

Illuminance must never fall below the recommended values. These are **service values**, designed to take account of the fact that with increasing length of service, illuminance decreases as lamps and luminaires age and become soiled and the reflectance of surfaces in the room declines. (60)

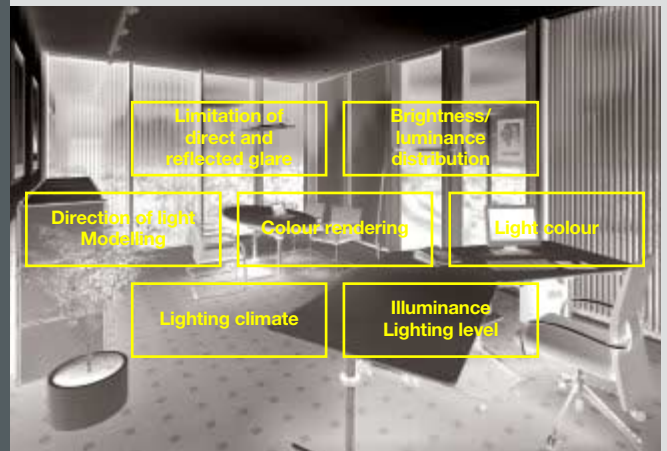

57

The quality features of lighting

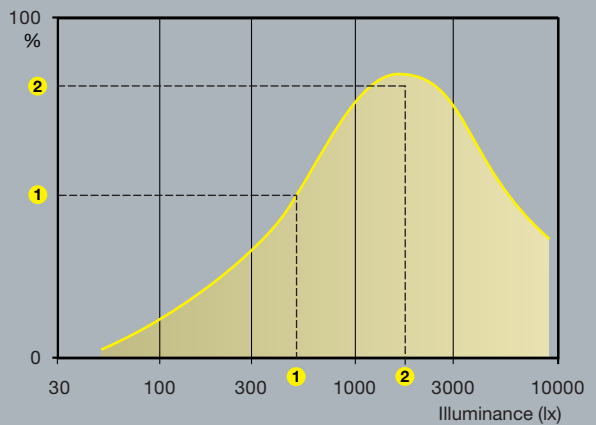

58

### Subjective appraisal of what constitutes a “good” lighting level for reading at an office workplace:

- 1 Half of respondents happy with illuminance values of 500 lx or more
- 2 A majority prefer illuminance values between 1000 and 3000 lx

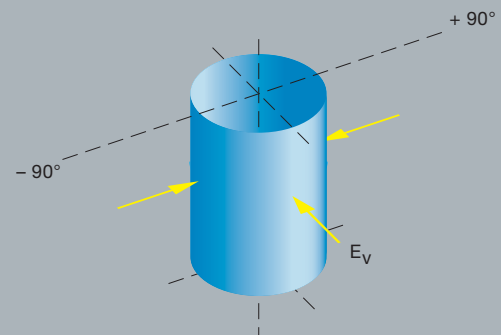

59

Cylindrical illuminance is the mean vertical illuminance on the surface of a cylinder



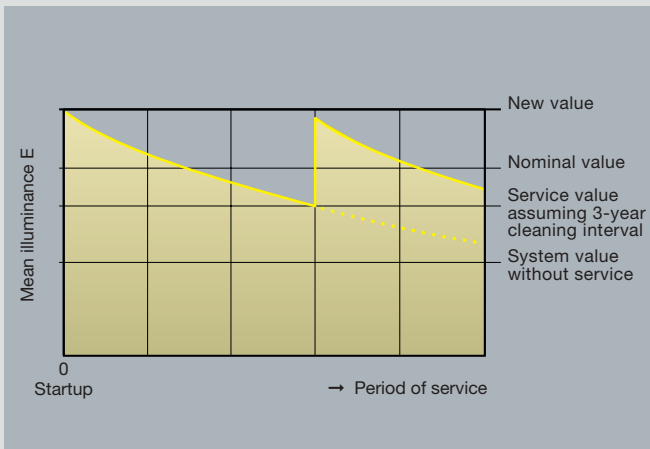

60  
New value, nominal value and service value are local mean values at different points in a lighting system's life

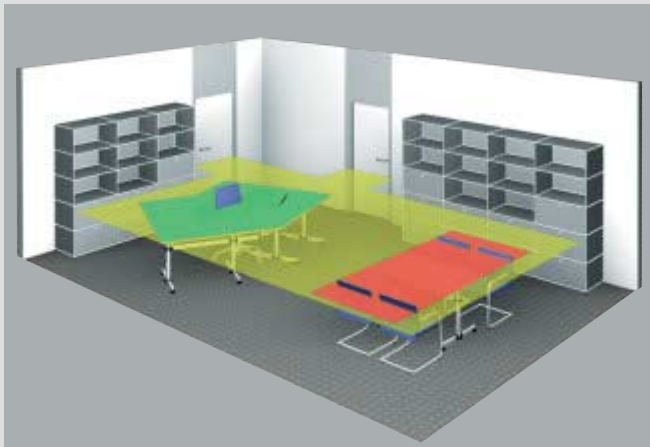

61  
Horizontal task areas in an office:  
"VDU work" (green), "conference" (red) and "surrounding area" (yellow).  
Illuminance value reference height: 0.75 m above floor level

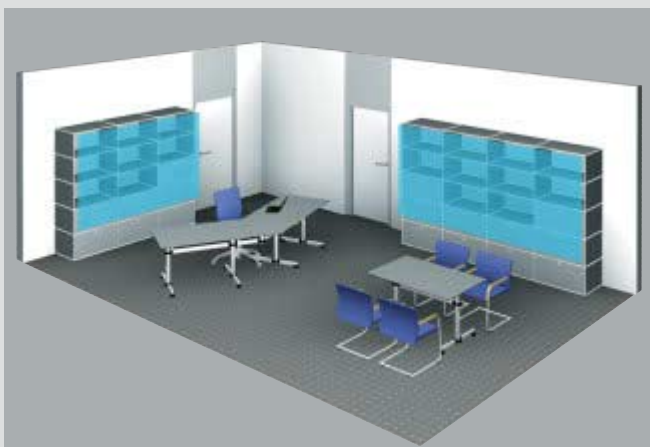

62  
Vertical task areas in an office:  
e.g. "cabinet and shelving system surfaces" (blue)  
Illuminance value reference height: starting at 0.5 m rising to 2 m above floor level, width according to objects

To compensate for this decrease, new lighting systems need to be designed for higher illuminance (new value). The decrease is then taken into consideration in planning by the application of a service factor: service factor x new value = service value.

The service factor depends on the types of lamps and luminaires used, exposure to dust and soiling in the room, service method and service intervals. In most cases, not enough is known at the lighting design stage about the factors that will define the rate of decrease in illuminance, so a service factor of 0.67 is applied for clean room conditions and 0.50 for dirty room conditions (e.g. rooms for smokers), assuming a three-year service interval and the use of modern lamps, electrical components and luminaires.

The illuminance values recommended apply to the **task area** in which the visual task is performed. The task area can be a horizontal (e.g. table), a vertical (e.g. map) or an inclined surface (e.g. drawing table). Task areas typically found in an office are desks, conference tables/areas, the vertical surfaces of cabinets and shelving systems, and stations for office machinery such as copiers and fax machines. (61, 62)

DIN 4543 defines a "desk" task area as a work surface (desktop) plus a user area, the two together measuring at least 1600 mm x 1800 mm. (63)

Cabinet and shelving system task areas extend from 0.5 m to 2.0 m above floor level.

Outside these task areas, a lower lighting level is permitted because the **surrounding space** is not used for the performance of demanding visual tasks.

The following table shows the illuminance values required for task and surrounding areas and the minimum uniformity of illuminance expressed as the quotient of minimum and mean values:

Task area	Surrounding area
$\geq 750 \text{ lx}$	500 lx
500 lx	300 lx
300 lx	200 lx
up to 200 lx	up to 200 lx
$E_{\min}/E_m$ min. 0.7	$E_{\min}/E_m$ min. 0.5



63  
Areas defined by DIN 4543:  
The VDU task area (green) consists of a work surface (white desktop) and a user area (red).

**G**lare is one of the most discomforting of all visual problems. An unshielded general-diffuse lamp or the bright reflection of a window on a VDU screen places considerable strain on our eyes. Glare can have physiological consequences, e.g. impairment of visual acuity. A bright reflection on a screen can obscure information and render it indecipherable. In most cases, glare has at least a psychological impact, causing fatigue and loss of concentration. Visual performance suffers and we make mistakes.

A distinction is made between direct glare and reflected glare. Direct glare occurs where a very bright point of light, e.g. the lamp of a luminaire, is located in the visual field. Direct glare can be avoided by the use of appropriate luminaires and correct positioning of luminaires and workplaces.

Reflected glare occurs as a result of disturbing reflections on shiny or reflective surfaces. These surfaces can be VDU screens, items of furniture or glossy paper. So to avoid reflected glare, it is necessary to look at not only the type and arrangement of luminaires in the room but also the materials and finishes of the office furniture and the positioning of monitors.

**Direct glare** from luminaires in the past was appraised by the luminance limiting curve method described in DIN 5035. (64)

Under the new European standard for interior workplace lighting DIN EN 12464, (psychological) glare is assessed by the unified glare rating method (UGR), which is based on a formula for glare. It takes account of all the luminaires in a system contributing to the sensation of

glare. Glare is then rated by reference to the formula-based UGR tables provided by lighting manufacturers. (65)

$$UGR = 8 \log \frac{0.25}{L_b} \sum \frac{L^2 \Omega}{P^2}$$

The two methods – the one set out in DIN 5035 and the one defined in DIN EN 12464 – produce comparable results.

**Reflected glare on shiny horizontal surfaces** (reading matter and paper for writing) is assessed by using the contrast rendering factor (CRF), which can be calculated by special software. For normal office work, a mean value of CRF = 0.7 is high enough; only work involving high-gloss materials calls for a higher value. (66)

**Reflected glare on VDU screens** is the most common cause of complaints. It is effectively avoided where monitors are arranged in such a way that bright surfaces such as windows, luminaires and bright walls cannot be reflected on screens. Where such an arrangement is not possible, the luminance of the surfaces reflected on screens needs to be reduced. For luminaires, DIN EN 12464 sets out luminance limits (68), which depend on the type and anti-glare design of the computer screen used and apply to all emission angles over 65° to the vertical all around the vertical axis. (67)

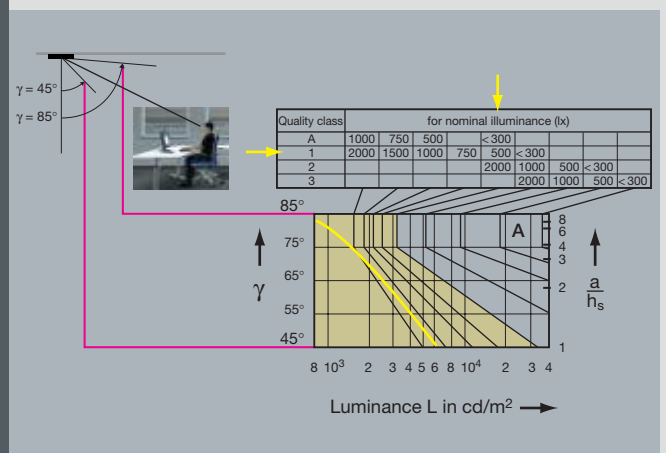

64

The currently used luminance limiting curve method defined in DIN 5035 assesses the mean luminance of luminaires in a zone of radiation from 45° to 85°. The new European standard sets UGR = 19 as a maximum permissible value for offices, which is equivalent to the luminance limiting curve for 500 lx in Quality Class 1.



65

The UGR method takes account of all the luminaires in the system which contribute to the glare sensation as well as the brightness of walls and ceilings. It produces a UGR index.

## Contrast rendering factors CRF and workplace requirements

Grade	Mean values	Minimum value	Application example
1	over 1,0	0,95	Work involving predominantly glossy materials, e.g. in graphic design offices
2	0,85 to 1,0	0,70	Work where glossy materials are occasionally used, e.g. in offices and schools
3	0,70 to 0,85	0,50	Tasks involving predominantly matt materials

66

Recommended CRF values for different materials used in office work



67

Depending on the class of VDU, the mean luminance of luminaires which could be reflected on the screen needs to be limited to 200 cd/m<sup>2</sup> or 1000 cd/m<sup>2</sup> above a threshold angle of radiation of  $\gamma \geq 65^\circ$  (calculated at 15° intervals all around the vertical axis) to avoid disturbing reflections.

VDUs	mean luminance of luminaires and surfaces which reflect on screens
Positive display VDUs	≤ 1000 cd/m <sup>2</sup>
Negative display VDUs with high-grade anti-reflective system Evidence of test certificate required	
Negative display VDUs with lower-grade anti-reflective system	≤ 200 cd/m <sup>2</sup>

68

Classification of VDUs on the basis of anti-reflective systems and type of display. The cd/m<sup>2</sup> values indicate the maximum permissible mean luminance of luminaires which could be reflected on the screen (in accordance with DIN EN 12464)

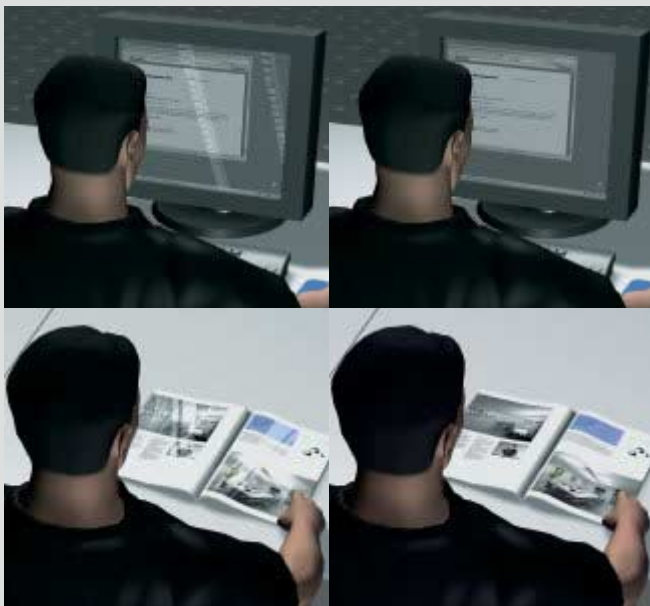

69

A positive (negative) display shows dark (light) characters on a light (dark) background. For a person to be able to register screen information without disturbance, VDUs with a lower-grade anti-reflective system require a greater reduction in luminaire luminance than high-grade anti-reflective screens. The table shows the maximum permissible mean luminance of luminaires which could be reflected on a screen (in accordance with DIN EN 12464). (68)

Without light, we cannot see three-dimensional objects. Without shadows, we see them only as two-dimensional images. The parameters that define the depth and body of an object are **direction of light** and **modelling** – because light and shadow play a vital role in enabling us to make out shapes, surfaces and structures. A bright room with only diffuse non-modelling light makes a monotonous impression; the lack of visual guidance and the difficulty in identifying objects and gauging distances cause discomfort.

Direction of light and modelling help define visual ambience. A good ratio of diffuse

light – e.g. from indirect lighting components – to directional light – e.g. from lowered luminaires or downlights – produces agreeable shadowing. The direction of light is generally determined by the daylight entering the room from a particular direction through the windows. Artificial lighting is used to prevent the excessive modelling that can result, for example, in disturbing shadows being cast ahead of our hand as we write.

Where luminaires are arranged parallel to a window wall, the rear row of luminaires can lighten any dark shadows that might occur during the day. As daylight fades, the front row of luminaires near the windows can be partially or fully activated to replace the natural lighting.

Unfavourable light distribution with disturbing shadows obscuring what has been “written”. The lower graphic shows the correct incidence of light and shadowing for a right-handed person: the light falls on the desk from top left and the hand does not cast a shadow over the writing area.



Disturbing reflection of luminaires on a screen and negative impact of reflected glare on the legibility of glossy documents. Both need to be avoided by careful positioning of luminaires or by limiting luminance.

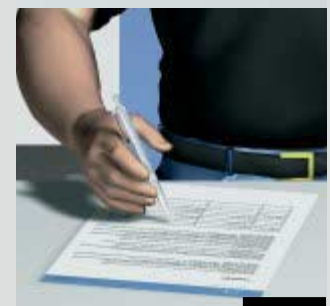

70

33

The light colour of a lamp is described in terms of the colour temperature  $T_f$  and units Kelvin (K).

The Kelvin temperature scale begins at absolute zero (0 Kelvin  $\approx$   $-273$  °C)

The colour temperature of a light source is defined by comparison with the colour of a "black-body radiator". A "black-body radiator" is an "idealised" solid body – e.g. made of platinum – which absorbs all light hitting it and therefore has a reflective radiance of zero.

When a "black body" is heated slowly, it passes through gradations of colour from dark red, red, orange, yellow and white to blue light. The higher the temperature, the whiter the colour. The temperature in K of a "black body radiator" at which it has the

same colour as the light source being measured is the most similar colour temperature of that light source.

Lamps with the same light colour can emit light of completely different spectral composition and therefore quite different colour rendering properties. It is not possible to draw conclusions about the quality of colour rendering from the light colour.

### The light colour of lamps:

Light colour	Colour temperature in Kelvin
warm white	< 3300
neutral white	3300 – 5000
daylight white	> 5000

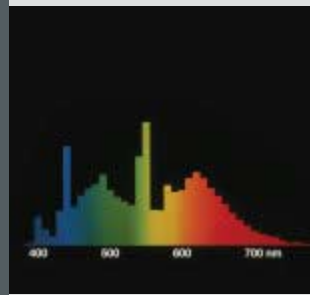

Light colour dw daylight white 72

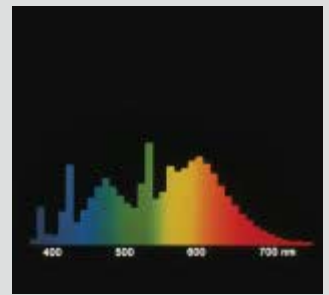

Light colour nw neutral white 73

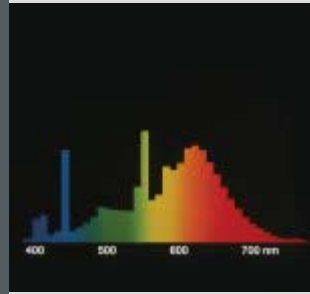

Light colour ww warm white 74

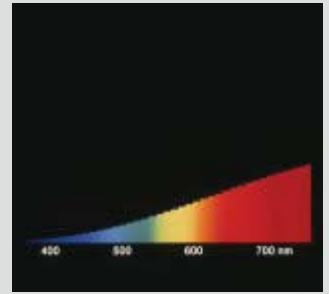

Light colour incandescent lamp 75

Fluorescent lamps have a line or band spectrum. Shown here as examples are the spectra of fluorescent lamps in each of the three groups dw, nw and ww.

In contrast, the incandescent lamp exhibits a continuous spectrum.

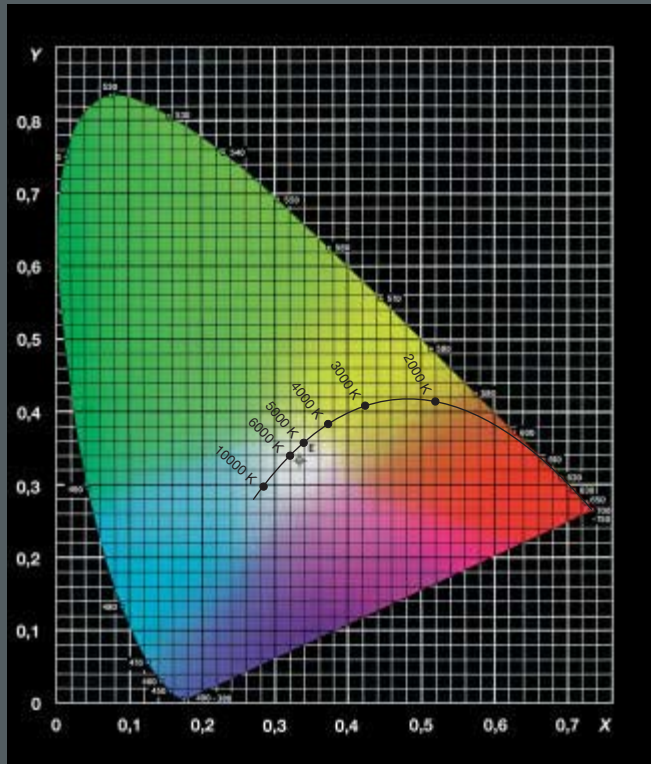

The International Commission on Illumination CIE has devised a triangle in which the colours of light sources and surface colours can be classified. Achromatic light, i.e. white, grey or black, is found at  $x = y = 0.333$ , depending on brightness. All the other colours lie around this point. Along the straight line from the achromatic position to the limiting curve

(which represents the spectral colours of sunlight) lie the colours of the same hue but differing degrees of saturation. The saturation increases towards the limiting curve. The colour triangle contains all real colours. The curve describes the colours of the "black-body radiator" for the temperatures given (in Kelvin).



Despite identical light colour, the different colour rendering properties of lamps lead to variations in colour perception. Where, for instance, the spectrum of a lamp contains only a little red light (right), red surface colours are only imperfectly rendered.

Colours have a significant bearing on the way we experience our surroundings. Whether a room has a warm or cold atmosphere is determined by the materials in it and their colours. The way the colours of objects are perceived, however, depends also on the **colour rendering** properties of the lighting.

The colour rendering index Ra indicates how well colours are rendered by lamps. Where lamps have a high index of 90 or more, all colours are rendered very accurately; where the index is lower, the colours we perceive are corrupted. Reds then look orange, greens appear yellow.

Lamps are divided for convenience into colour rendering categories. Most lamps have a colour rendering index of over 80 and thus render colours well enough for us to perceive them as natural. Incandescent lamps, tungsten-halogen lamps, certain metal halide lamps and a number of fluorescent lamps have a colour rendering index of over 90, which means they render all colours very accurately.



77

Owing to stored “visual standards”, skin colour is perceived as natural even where colour rendering departs from the daylight norm. Colour rendering needs to be good.



78



79

Artificial lighting using lamps with very good colour rendering (colour rendering index  $R_a > 90$ ) reproduces all surface colours accurately.



80

# Minimum lighting requirements

## Minimum lighting requirements recommended by E DIN 5035-7

Type of interior	Lighting concept and visual task	Horizontal illuminance	Cylindrical illuminance	Vertical illuminance	UGR <sub>L</sub>	R <sub>a</sub>	Remarks	
		$\bar{E}_{h,m}$ lx	$\bar{E}_{z,m}$ lx	$\bar{E}_{v,m}$ lx				
Offices and similar rooms	<b>Room-related lighting</b>	500	175					
	– throughout the room, less a 0.5 m fringe				19	80	$\bar{E}_{h,m}: g_1=0.6$	$\bar{E}_{z,m}: g_1=0.5$
	– cabinet and shelving system surfaces			175	19	80	$g_1=0.5$	
	<b>Task area lighting</b>	500	175					
	– VDU work	500	175		19	80	$\bar{E}_{h,m}: g_1=0.6$	$\bar{E}_{z,m}: g_1=0.5$
	– conference				19	80	$\bar{E}_{h,m}: g_1=0.6$	$\bar{E}_{z,m}: g_1=0.5$
	– cabinet and shelving system surfaces	300		175	19	80	$g_1=0.5$	
	– surrounding area				19	80	$g_1=0.5$	
	<b>Work surface lighting</b>	750						
	– work surface 600 x 600 mm	500	175		19	80	$g_1=0.7$	
– task area VDU work incl. work surface	500	175		19	80	$E_{h,min} \geq 300$ lx	$\bar{E}_{z,m}: g_1=0.5$	
– conference				19	80	$\bar{E}_{h,m}: g_1=0.6$	$\bar{E}_{z,m}: g_1=0.5$	
– cabinet and shelving system surfaces	300	100	175	19	80	$g_1=0.5$		
– surrounding area				19	80	$\bar{E}_{h,m}: g_1=0.5$	$\bar{E}_{z,m}: g_1=0.5$	
Individual VDU workplaces	<b>Task area lighting</b>	500						
	– VDU work						$g_1=0.6$	
	<b>Work surface lighting</b>	750						
– work surface 600 x 600 mm	500					$g_1=0.7$		
– task area VDU work incl. work surface						$E_{h,min} \geq 300$ lx		

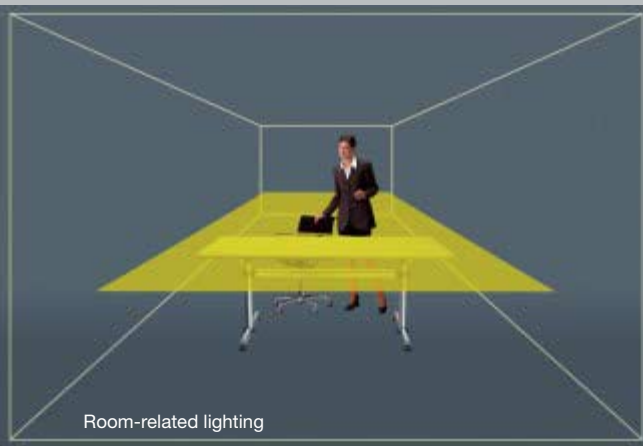

81

### Room-related lighting

Uniform lighting throughout the room creating roughly the same visual conditions at all points. This is recommended where the arrangement of task areas is unknown during the planning phase or where the arrangement of task areas needs to be flexible.

### Task area lighting

Different lighting for task areas and the space around them. This is recommended where a room contains several task areas which are used to address different visual tasks and thus have different lighting requirements. It is also an option where visual divisions are needed to identify different workplace clusters.

### Work surface lighting

Workplace luminaires can be used to supplement “basic lighting” – which can be either room-related or task area lighting – to achieve a level of lighting finely tuned to the requirements of the visual task or personal needs. DIN 5035-8 sets out requirements and recommendations for workplace luminaires.

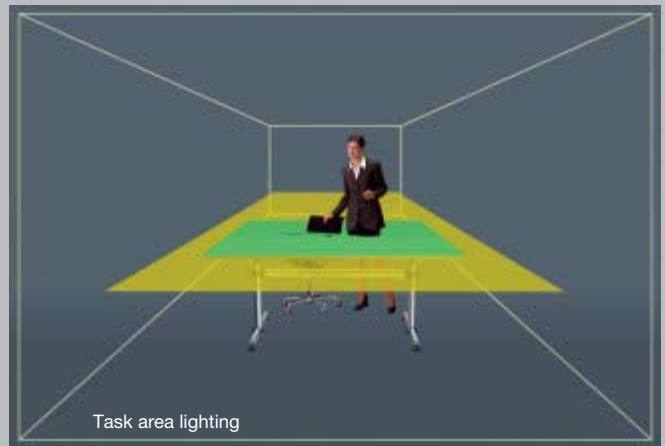

82

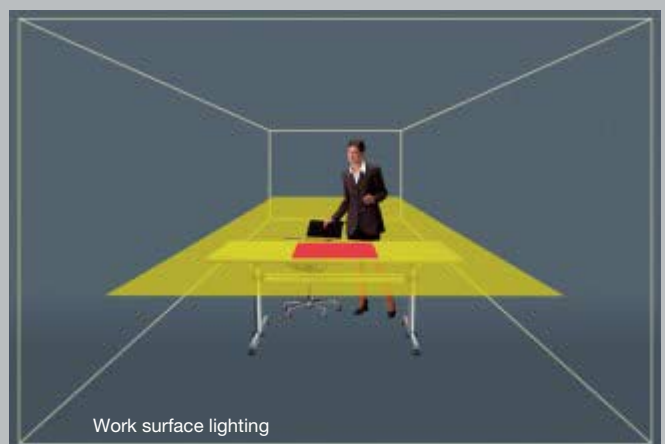

83

## Minimum lighting requirements recommended by DIN EN 12464

Type of visual task		illuminance on visual task plane $\bar{E}_m$ lx	UGR <sub>L</sub>	R <sub>a</sub>	Remarks
Office work	filing, copying	300	19	80	
	communication zones in work rooms	300	19	80	
	writing, typewriting	500	19	80	
	reading, data processing	500	19	80	
	CAD workplaces	500	19	80	
	conference and meeting rooms	500	19	80	lighting adjustable
	reception desk	300	22	80	
	archives	200	25	80	
Public areas, service halls	entrance halls	100	22	80	UGR <sub>L</sub> only where applicable
	cloakrooms	200	25	80	
	waiting rooms	200	22	80	
	cashdesks and service points	300	22	80	
Conventional design and drafting offices	drafting rooms	500	19	80	
	art school drawing rooms	750	19	90	colour temperature ≥ 5000 K
	rooms for technical drawing	750	16	80	
Ancillary rooms	transport and communication routes				
	– not for persons	20	–	40	
	– for persons	100	28	40	
	– for persons and vehicles	150	28	40	
	staircases, escalators, moving walkways	150	25	40	
	canteens	200	22	80	
	counter	300	22	80	
	rest rooms	100	22	80	
	physical exercise rooms	300	22	80	
	tearooms	200	22	80	
	kitchen	500	22	80	
	changing rooms, washrooms and toilets	200	25	80	
	first aid rooms	500	19	80	colour temperature ≥ 4000 K
	medical service rooms	500	16	90	
	building service management rooms, control rooms	200	25	60	
telex and mail rooms, telephone exchange workplaces	500	19	80	200 lx, where permanently manned	
storage rooms and warehouse facilities	100	25	60		
despatch and packaging areas	300	25	60		
Outdoor facilities	Gates	50			g <sub>1</sub> = 0.5
	works roads	10			g <sub>1</sub> = 0.4
	with max 30 km/h speed limit				
	pathways	5			g <sub>2</sub> ≥ 0.08
	cycle paths	$E_{min} \geq 3$			g <sub>2</sub> ≥ 0.3
	car-parks with low traffic load	7			g <sub>1</sub> = 0.2
	garages without daylight				
	– transport routes	75	25	20	
	– parking spaces	75	–	20	
	– vehicle entrances and exits at night	75	25	20	
	– vehicle entrances and exits during the day	300	25	20	
	– ticket windows	300	19	80	

### Notes on the tables

$\bar{E}_{h,m}$  is the service value of illuminance at the visual task, which is generally on a horizontal plane and, in the case of desks, 0.75 m above floor level. In the case of communication routes, this assessment value is max. 0.2 m above floor level.

$\bar{E}_{z,m}$  is the service value of cylindrical illuminance 1.2 m above floor level. It defines how well we identify three-dimensional objects such as figures, faces, etc., and is particularly important for visual communication.

$\bar{E}_{v,m}$  is the service value of vertical illuminance on cabinet and shelving system walls which is needed for the performance of visual tasks, e.g. reading file and book spines.

**g<sub>1</sub>; g<sub>2</sub>** uniformity of illuminance:  $g_1 = E_{min} / \bar{E}_m$ ;  $g_2 = E_{min} / E_{max}$

**UGR<sub>L</sub>** limiting glare index according to the unified glare rating system

**R<sub>a</sub>** general colour rendering index

**B**elow are the most important types of lamp for office applications.

### 1, 2, 3 Linear three-band fluorescent lamps

26 mm (T8) and 16 mm (T5) dia. three-band fluorescent lamps have a high luminous efficacy, good colour rendering properties and a long service life. They are available in the light colours warm white (ww), neutral white (nw) and daylight white (dw). Operated by electronic ballasts (EBs), they achieve an even higher luminous efficacy and longer service life. T5 lamps are designed for EB operation only. Dimming control of three-band fluorescent luminaires is possible with appropriate EBs.

### 4, 5, 6, 7 Compact fluorescent lamps

Compact fluorescent lamps generate light in the same way as linear fluorescent lamps. They have thin interconnected fluorescent tubes positioned side by side and require a ballast and starter for operation. Starters are generally integrated in the lamps. Dimming and starterless operation are possible with EBs, which also make for higher luminous efficacy and longer service life.

### 8, 9, 10 Energy-saving lamps

Energy-saving lamps are compact fluorescent lamps with an integrated electronic ballast. They have either a screw base (E14/E27) or a bayonet base (GX53). Energy-saving lamps consume 80% less power and have a considerably longer life than incandescent lamps with the same power rating.

### 11, 12, 13 230 V halogen lamps

These lamps are designed for direct line operation. They produce an agreeable, fresh white light and lend themselves readily to dimming. Halogen lamps have a longer life than incandescent lamps and generate more light from the same power. Thanks to the halogen process, lumi-

nous flux remains constant throughout the life of the lamp (no bulb blackening).

### 14, 15 Low-voltage halogen lamps

To operate these lamps, a transformer is needed to reduce the voltage to 12 V. Low-voltage halogen lamps have a UV shield, which eliminates undesirable UV rays from the light they radiate.

### 16, 17 Metal halide lamps

These lamps are noted for their high luminous efficacy and excellent colour rendering properties. Because of the small dimensions of their burner, they make particularly good sources of directional light. The ceramic burner produces light of a constant colour throughout its service life. An inductive ballast and starter or EB are needed to operate metal halide lamps.

### 18 Light-emitting diodes (LEDs)

LEDs have a very long service life, so they rarely need to be replaced. They are extremely small, very powerful considering the voltage and currents they operate on, have a high resistance to impact and emit neither IR nor UV radiation. They are designed for 24 Volt d.c. operation. LEDs are available in many colours, e.g. blue, green, yellow and red. The special fluorescent coating in blue LEDs produces daylight white light (6,000 K) with good colour rendering properties ( $R_a = 80$ ). Important lighting applications for LEDs are orientation and decorative lighting.

The illustration on the right shows LEDs on a flexible printed-circuit board.

No. Lamp type

#### Linear three-band fluorescent lamps

1	T5; 16 mm dia. – high luminous efficacy <sup>1)</sup>
2	T5; 16 mm dia. – high luminous flux <sup>1)</sup>
3	T5; 26 mm dia.

#### Compact fluorescent lamps

4	2-, 4-, 6-tube lamp
5	2-tube lamp
6	4-tube lamp
7	2D lamp

#### Energy-saving lamps

8	Miniature
9	Candle
10	Incandescent-shape

#### 230 V halogen lamps

11	with jacket
12	with reflector
13	with base at both ends

#### Low voltage 12 V halogen lamps

14	pin-based lamps
15	with reflector

#### Metal halide lamps

16	with base at one end
17	with base at both ends

#### Light emitting diodes

18	LEDs on flexible printed-circuit board
----	--

<sup>1)</sup> for EB operation only

<sup>2)</sup> luminous flux at 25°C





Power rating W	Luminous flux lm	Luminous efficacy lm/W	Light colour	R <sub>a</sub>	Base
14 – 35	1200 – 3300 <sup>2)</sup>	86 – 94	ww, nw, dw	80 < 90	G5
24 – 80	1750 – 6150 <sup>2)</sup>	73 – 77	ww, nw, dw	80 < 90	G5
18 – 58	1350 – 5200	75 – 90 <sup>3)</sup>	ww, nw, dw	80 < 90	G13
5 – 57	250 – 4300	50 – 75	ww, nw	80 < 90	GX24, G23/24, 2G7
18 – 80	1200 – 6000	67 – 75	ww, nw, dw	80 < 90	2G11
18 – 36	1100 – 2800	61 – 78	ww, nw	80 < 90	2G10
10 – 55	650 – 3900	65 – 71	ww, nw, dw	80 < 90	GR8, GR10q, GRY10q-3
7	220	31	ww, nw	80 < 90	GX53
5 – 12	150 – 600	30 – 50	ww	80 < 90	E14
5 – 23	150 – 1350	30 – 59	ww	80 < 90	E27
25 – 250	260 – 4300	10 – 17	ww	≥ 90	E14, E27
40 – 100	–	–	ww	≥ 90	E14, E27, GZ10, GU10
60 – 2000	840 – 44000	14 – 22	ww	≥ 90	R7s
5 – 100	60 – 2200	12 – 22	ww	≥ 90	G4, GY6,35,
20 – 50	–	–	ww	≥ 90	GU5,3
35 – 150	3300 – 14000	85 – 95	ww, nw	80 < 90, ≥ 90	G12, G8,5
70 – 400	6500 – 14000	90	ww,nw	80 < 90, ≥ 90	RX7s, Fc2
0,7 – 1,5	18 – 27	13 – 23	–	–	special

<sup>3)</sup> luminous efficacy increases to 81 – 100 lm/W with EB operation



# Luminaires

Part 1 | 2

**D**ifferent types of luminaire are needed for office lighting, their selection depending on the nature of the building, the kind of visual activity performed, room dimensions, daylight incidence and interior decoration and furnishings. Together, as individual elements or as lighting groups, they form the building's lighting systems – developed in consultation with all the different specialists involved in office design. The range of lighting tools available spans surface-mounted, recessed, pendant, wall, desktop, table and standard luminaires as well as spots in a wide variety of power ratings and designs.

From this range of available luminaires, selection can be based on lighting, electrical and design characteristics.

## Lighting characteristics

Information on the lighting characteristics of a luminaire is provided by its intensity distribution curve (IDC). This shows the pattern of illuminance the luminaire creates and is used for assessing glare.

Another important lighting criterion for luminaires is light output ratio, which indicates the proportion of lamp luminous flux available in the room. The higher the ratio, the greater the efficiency and economy with which the luminaire harnesses the luminous flux of its lamps.

The decision for or against a luminaire for a particular application can also be swayed by the standard of glare limitation the luminaire achieves.

Glare limitation means effective shielding of lamps at critical angles, which significantly enhances the quality of lighting.

1 Recessed luminaire with prismatic diffuser

2 Recessed luminaire with specular louvers

3 Recessed wallwasher

4 Square recessed louvered luminaire

5 Surface-mounted luminaire with specular louvers

6 Square surface-mounted louvered luminaire

7 Pendant luminaire with specular louvers for direct/indirect lighting

8 Pendant luminaire with optical control panels for direct/indirect lighting

9 Tubetrack system with three-phase power track and spots

1

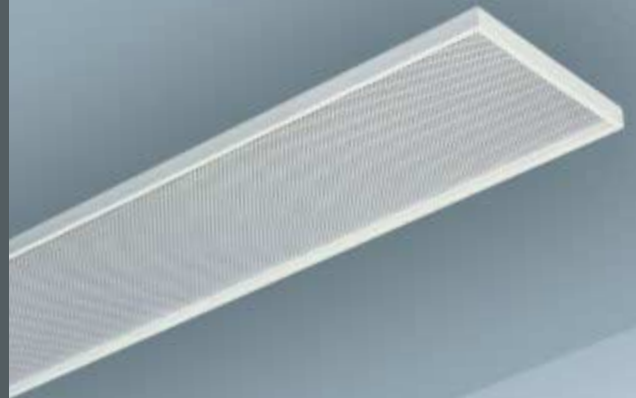

4

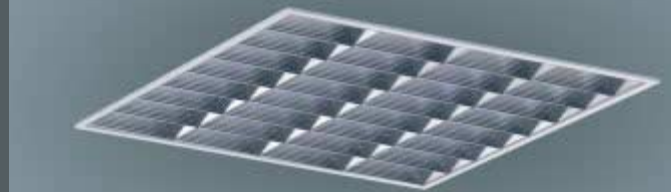

7





# Luminaires

Part 1 | 2

## Electrical characteristics

The electrical characteristics of a luminaire depend, in part, on the kind of electrical components it features for safe, fault-free lamp operation. With fluorescent lamps, for example, greater energy efficiency – i.e. lower system power consumption – can be achieved by the use of electronic ballasts (EBs). EBs also double as starters and p.f. correction capacitors and discontinue starting attempts if the lamp is defective. To meet lighting safety requirements, luminaires and integrated electrical control gear must comply with IEC 598 regulations and display the ENEC symbol.

## Design characteristics

Design characteristics are also, of course, an important factor to consider when choosing luminaires. The nature of the ceilings in a building, for example, may prescribe or preclude the use of surface-mounted, recessed or pendant luminaires. Assembly and maintenance are another significant aspect, and a touchstone of luminaire construction. Well-designed assembly aids or practical installation accessories can simplify considerably the task of installing luminaires.

The appearance of a luminaire – i.e. shape of housing, finishes and colours – greatly affects the visual impact of an interior and, along with reliability, economy and stability of value, is becoming an increasingly important criterion for luminaire selection.

10 Surface-mounted reflector luminaires

11 Recessed downlight

12 Surface-mounted downlight

13 Standard luminaires for indirect or direct/indirect lighting

14 Workplace or desktop luminaires

15 Wall luminaires

16 Decorative recessed spots

17 Recessed floor and wall luminaires

18 Escape sign luminaire

10

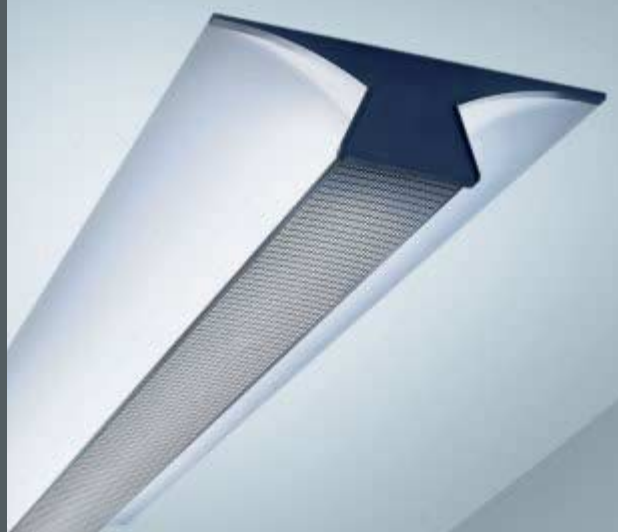

13



16



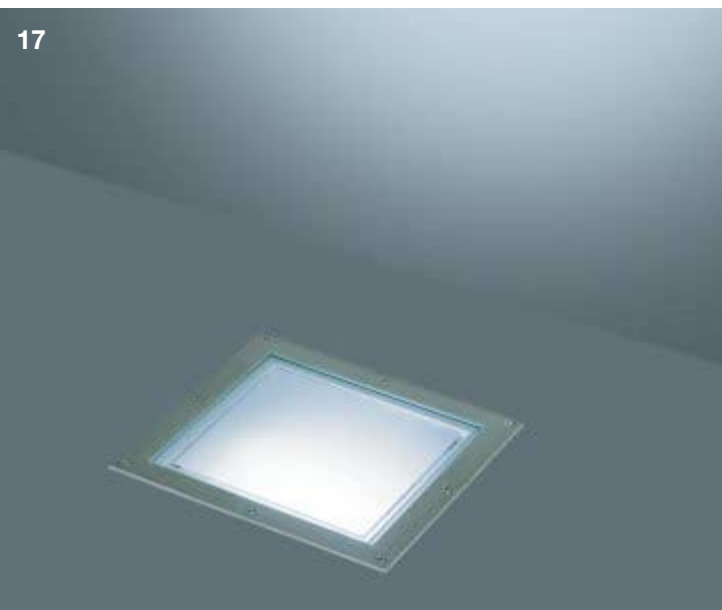

Light has an emotional impact. The right light at the right place in the right quantity stimulates and fosters a sense of well-being. In office and administrative buildings in particular, lighting management plays a central role, providing the regulation needed to produce light that activates, motivates and helps maintain contentment and concentration. It also ensures the optimal visual comfort and maximum visual performance that most activities require for effective work, especially at VDU workplaces.

Aside from that, lighting management means generating dynamic lighting for differentiated lighting landscapes. One important function it performs is to adjust lighting levels in line with fluctuations in daylight, another is to avoid the uniform lighting levels that lead to visual fatigue. So the objective of good lighting management is to achieve a dynamic combination of daylight and artificial lighting which harnesses the stimulating differences and interaction between the two.

With more and more areas of office and administrative buildings performing not just a productive but also a representative function, lighting management is also needed to help cast rooms in the right light. Pre-programmed or variable lighting scenes define mood and direct attention, picking out focal points and creating the right visual ambience. For seminars and conferences involving multimedia presentations in particular, effective and individual lighting management is an essential element of interior design.

Another important aspect is economy. Lighting management systems save as much as 60% of the energy costs of operating artificial lighting; electronic ballasts make for not only significantly higher luminous efficacy but also short lamp starting times for

flicker-free lighting and lower maintenance costs due to longer intervals between relamping.

Daylight- and presence-dependent lighting control systems make for significant energy savings in many parts of office and administrative buildings. In most corridors and stairwells, and in many offices as well, lighting is switched on in the morning and off in evening regardless of fluctuations in daylight incidence or the fact that the corridor or office might not be used for several hours.

Lighting in individual rooms or small building units can be simply, flexibly and conveniently regulated by DALI components. DALI (Digital Addressable Lighting Interface) is a digital interface for electronic ballasts (EBs) operating discharge lamps.

DALI is an independent system which controls all the lighting system components in a room and also offers the possibility of exchanging information through a gateway with a higher-level building services management system. This permits central switching and scanning, e.g. for defective lamps.

The working group AG DALI, which operates under the wing of the German electrical and electronics association Zentralverband Elektrotechnik- und Elektronikindustrie e.V. (ZVEI), numbers Europe's leading electronic lighting component manufacturers among its members. The ZVEI also provides information on the subject of lighting management and DALI.



84

Lighting regulation and control today are a task for computers. Special hardware and software permit full lighting management and economical use of artificial lighting.

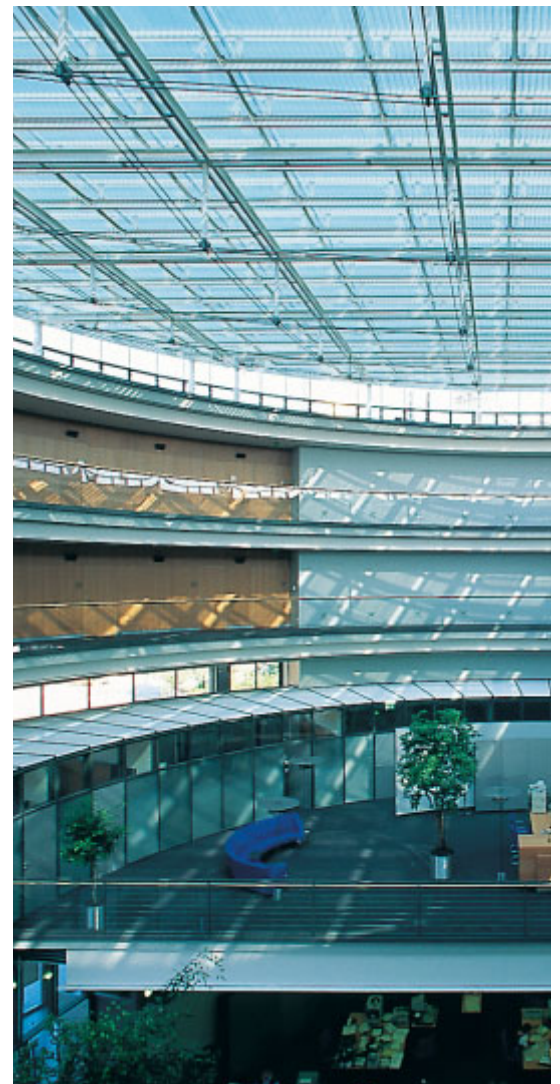

85

Daylight is still the best form of lighting around. Intelligent computerised lighting systems use artificial lighting as a daylight supplement.



86

In the morning, incident daylight is generally enough for tasks performed at a desk. The row of luminaires near the window is dimmed down, the row behind it illuminates the entrance area and makes for a uniform distribution of brightness in the room.



87

At mid-day, the room is illuminated by bright daylight. Both rows of luminaires are deactivated. On a cloudy day, the sensor-controlled rows of luminaires maintain the illuminance throughout the room at an agreeably high level.



88

In the evening, the artificial lighting takes over. The two rows of luminaires are equally bright and ensure a harmonious distribution of brightness throughout the room. As soon as the room is vacated, presence detectors reduce the illuminance or deactivate the lighting.



89

In rooms which need to cater to various sets of lighting requirements, such as conference rooms or lecture halls, regulation and control of the different types of lighting required are facilitated by computerised lighting management systems. These permit pro-



grammed lighting scenes to be fine-tuned to requirements and stored for re-use at any time. For lectures and receptions, conferences and video presentations, the best possible room lighting is thus available at the push of a button.

**L**ighting is an important cost factor in the construction and operation of an office and administrative building. However, artificial lighting accounts for only 1–2% of the investment costs of equipping and furnishing a workplace. The building, furniture and computer equipment costs are a great deal higher. 80% of the total bill relates to personnel expenses, 16% to operating expenses and 4% to construction expenses. Lighting can account for as much as a third of operating costs.

So it is all the more important that employees should work efficiently. Good lighting is not only important for visibility at desks and in the room: it also plays a key role in fostering a sense of well-being and thus enhancing staff performance. According to a study, 57% of employees find their office lighting a source of disturbance. After dry air and noise, poor lighting is the third most frequent complaint.

Two cost factors need to be considered when selecting a lighting system for a new or refurbished building: capital costs (i.e. the cost of acquisition and assembly) and operating costs (electricity, replacement lamps, maintenance). An efficient modern lighting system reduces annual operating costs and pays for itself within the space of a few years, even where acquisition costs are relatively high.

New lamp and luminaire technologies permit more economical lighting system operation and a better quality of lighting than even a few years ago. Newly developed lamps, such as T5 fluorescent lamps and compact fluorescent lamps, make for higher luminous efficacy. Electronic ballasts reduce internal losses and offer flicker-free lighting and better lamp starting performance. New reflector materials and designs heighten the light output ratio and degree of glare suppression of luminaires.

In lecture halls, lighting management systems enable the right lighting situation for the occasion to be selected at any time. For service operations, for example, computerised control allows the level of brightness in the room to be reduced to the minimum required for the task. For lectures, certain spots and specific parts of the accent lighting system can be activated alone at the push of a button.

With modern, power-saving fluorescent lamps, daylight domes at night can be turned into luminous ceilings. Only a few luminaires are needed to provide bright agreeable room lighting and create an inviting atmosphere. The lighting management system regulates the artificial lighting and produces light similar to daylight, even of a similar light colour, if required. Options range from daylight white through neutral white to warm white.

Lots of glass in façades considerably reduces the need for artificial lighting during the day and gives the building a more open, more inviting appearance at night. Illuminated architectural elements or entrance zones bring the image to life and guide the visitor into the building. Powerful modern floodlights with metal halide lamps permit economical dramatic lighting.



90



91



92



# Literature, standards and LiTG publications/ acknowledgements for photographs

## Literature, standards and LiTG publications

The texts for the sections "Office design" (pages 4 and 5) and "Features" (pages 9 to 23) of this booklet are based on:  
Lorentz, D: "Büro nach Maß, aktuelle Büroformen im Vergleich" (The customised office – A comparison of contemporary office types), in Knirsch, J.: "Büroräume . Bürohäuser" (Offices · Office buildings), published by Verlagsanstalt Alexander Koch, Leinfelden-Echterdingen, 2nd enlarged and updated edition 2002; pp 58 – 70.

### FGL Information on Lighting Applications

For more information on issues addressed in Booklet 4, see booklets 1, 3, 10, 12 and 16

### LiTG

Publication 12.2: 1996 "Messung und Beurteilung von Lichtimmissionen künstlicher Lichtquellen" (Measurement and assessment of light immissions from artificial light sources)

Publication 13: 1991 "Der Kontrastwiedergabefaktor CEF – ein Gütemerkmal der Innenraumbelichtung" (Contrast rendering factor CRF – an interior lighting quality factor)

Publication 16: 1998 "Energiesparlampen – ein Kompendium zu Kompaktleuchtstofflampen mit integrierten Vorschaltgeräten" (Energy-saving lamps – a compendium of compact fluorescent lamps with integrated ballasts)

Publication 18: 1999 "Verfahren zur Berechnung von horizontalen Beleuchtungsstärken in Innenräumen" (Methods for calculating horizontal illuminance in interiors)

Publication ##: "Das UGR-Verfahren zur Bewertung der Direktblendung der künstlichen Beleuchtung in Innenräumen" (The UGR method of assessing direct glare from artificial lighting in interiors) (in preparation)

### ZVEI

DALI-Handbuch (DALI manual), Fachverband Elektroleuchten im ZVEI, Frankfurt/Main

**VBG BGI 650** Bildschirm- und Büroarbeitsplätze (VDU and office workplaces)

**VBG BGI 827** Sonnenschutz im Büro (Sunscreening in offices)

**VBG BGI 856** Beleuchtung im Büro (Office lighting)

**DIN EN 12464-1** Light and lighting – Lighting of work places – Part 1: Indoor work places (due for publication mid-2003)

**DIN 5035** Artificial lighting. Some of the contents of Parts 1, 2, 3 and 4 of DIN 5035 are superseded by DIN EN 12464, others remain operative. Part 5 has been replaced by DIN EN 1838.

**DIN 5035-6** Measurement and evaluation

**E DIN 5035-7** Lighting for rooms with VDU work stations or VDU-assisted workplaces

**DIN 5035-8** Special requirements for the lighting of single work-places in offices and similar rooms

**DIN 4543-1** Office work place, Part 1 Space for the arrangement and use of office furniture ; safety requirements, testing

**DIN EN ISO 9241-6** Ergonomic requirements for office work with visual display terminals (VDTs). Part 6: Guidance on the work environment

**DIN EN 1838** Emergency lighting

**DIN 5044** Permanent traffic lighting

**ASR 7/3** Workplace guideline on "Lighting"

## Acknowledgements for photographs

1

Top left and bottom left: König+Neurath, 61184 Karben;  
right: Steelcase-Werndl, 83026 Rosenheim

**4, 9, 13, 15, 20, 25, 28, 34, 37, 43, 49 and middle of back cover**  
Image Source AG, 50939 Köln

**22, 40, 78, 79**

Kress & Adams, Atelier für Lichtplanung, 50735 Köln

**80**

Valentin Wormbs, 70180 Stuttgart

**All other photos, 3D visualisations and graphics**  
Fördergemeinschaft Gutes Licht (FGL)

For documentary assistance with the work for this booklet, we wish to thank:  
plus+bauplanung GmbH, Hübner-Forster-Hübner Freie Architekten, 72654 Neckartenzlingen and Electric Exclusiv, 50667 Köln

## Order form

Please tick booklet(s) required. Prices given include postage. (G = available only in German; P = available only as pdf file, download at [www.licht.de](http://www.licht.de));

Booklet No./Title	Qty	Price	Notes
1 Lighting with Artificial Light (5/00)		€ 9,-	
2 Good Lighting for Schools and Educational Establishments(1/94)*		€ 9,-	
3 Good Lighting for Safety on Roads, Paths and Squares (3/00)		€ 9,-	
4 Good Lighting for Offices and Office Buildings (1/03)		P	
5 Good Lighting for Trade and Industry (4/99)		€ 9,-	
6 Good Lighting for Sales Premises and Shop Windows (2/02)		P	
7 Good Lighting for Health Care Premises (7/94)*		€ 9,-	
8 Good Lighting for Sports Facilities (9/01)		P	
9 Prestige Lighting (8/97)		€ 9,-	
10 Notbeleuchtung, Sicherheitsbeleuchtung (4/00)		€ 9,-	G
11 Good Lighting for Hotels and Restaurants (4/00)		€ 9,-	
12 Economical Lighting Comfort with Lighting Electronics (8/96)*		€ 9,-	
13 – out of print –		-	G
14 Ideen für Gutes Licht zum Wohnen (9/99)		€ 9,-	G
15 Gutes Licht am Haus und im Garten (9/94)		-	G
16 Urban image lighting (4/02)		-	G
Lichtforum		P	
		free of charge	

\* New edition in preparation

Place

Date

Signature/stamp

From

Name, Company, Office

Department

c/o

Address or P.O. Box

City, Postal Code

Postcard

Postage stamp

Fördergemeinschaft  
Gutes Licht  
Postfach 70 12 61

60591 Frankfurt am Main  
Germany

3/03/00/4 IVE

## Imprint

# 4

This booklet is No. **4** in the series **Information on Lighting Applications** published by Fördergemeinschaft Gutes Licht (FGL) to provide information on good lighting with artificial light.

**The titles and numbers of all the booklets in this series are given on the opposite page.**

**All the German booklets are available as print versions, with Booklets 3, 4, 6, 8 and 16 additionally available as pdf files for downloading at [www.licht.de](http://www.licht.de). The English version of Booklet 3 is also published in both print and pdf format, while Booklets 4, 6, 8 and 16 are available in English for download only.**

### Publisher:

Fördergemeinschaft  
Gutes Licht (FGL)  
Stresemannallee 19  
60596 Frankfurt am Main  
Germany  
phone ++49 (0)69 63 02-0  
fax ++49 (0)69 63 02-317  
e-mail [fgl@zvei.org](mailto:fgl@zvei.org)  
[www.licht.de](http://www.licht.de)

### Technical consultant:

Fördergemeinschaft  
Gutes Licht

### Overall design:

IMAGORATIO  
Köln

### 3D visualisations:

JARO Medien  
Mönchengladbach

### Lith film:

Donner & Nagel  
Essen

### Printed by:

westermann druck  
Braunschweig

### Acknowledgements:

The booklets in this series contain references to current DIN standards and VDE stipulations.

DIN standards:  
Beuth-Verlag, 10787 Berlin,  
Germany

DIN-VDE standards:  
VDE-Verlag, 10625 Berlin,  
Germany

### ISBN:

3-926 193-20-04

### Reprint:

With the permission  
of the publishers.  
3/03/00/4IVE

## Order form

Please tick booklet(s) required. Prices given include postage. **G** = available only in German; **P** = available only as pdf file, download at [www.licht.de](http://www.licht.de):

Booklet No./Title		Qty
1 Lighting with Artificial Light (5/00)	€ 9,-	
2 Good Lighting for Schools and Educational Establishments(1/94)*	€ 9,-	
3 Good Lighting for Safety on Roads, Paths and Squares (3/00)	€ 9,-	
4 Good Lighting for Offices and Office Buildings (1/03)	P	
5 Good Lighting for Trade and Industry (4/99)	€ 9,-	
6 Good Lighting for Sales Premises and Shop Windows (2/02)	P	
7 Good Lighting for Health Care Premises (7/94)*	€ 9,-	
8 Good Lighting for Sports Facilities (9/01)	P	
9 Prestige Lighting (8/97)	€ 9,-	
10 Nebbeleuchtung, Sicherheitsbeleuchtung (4/00)	G	
11 Good Lighting for Hotels and Restaurants (4/00)	€ 9,-	
12 Economical Lighting Comfort with Lighting Electronics (8/96)*	€ 9,-	
13 - out of print -	G	
14 Ideen für Gutes Licht zum Wohnen (9/99)	G	€ 9,-
15 Gutes Licht am Haus und im Garten (9/94)	G	-
16 Urban image lighting (4/02)	P	
Lichtforum	free of charge	
* New edition in preparation		

### From

Name, Company, Office  
Department  
c/o  
Address or P.O. Box  
City, Postal Code

### Postcard

Fördergemeinschaft  
Gutes Licht  
Postfach 70 12 61  
60591 Frankfurt am Main  
Germany

Postage  
stamp

Place

Date

Signature/stamp

Please fill in address on back of postcard.

3/03/00/4IVE

**F**ördergemeinschaft Gutes Licht (FGL) provides information on the advantages of good lighting and offers extensive material dealing with every aspect of artificial lighting and its correct usage. FGL information is impartial and based on current DIN standards and VDE stipulations.

## Information on Lighting Applications

The booklets 1 to 16 in this series of publications are designed to help anyone who becomes involved with lighting – planners, decision-makers, investors – to acquire a basic knowledge of the subject. This facilitates cooperation with lighting and electrical specialists. The lighting information contained in all these booklets is of a general nature.

## Lichtforum

Lichtforum is a specialist periodical devoted to topical lighting issues and trends. It is published at irregular intervals.

## www.licht.de

FGL is also on the Internet. Its website

[www.licht.de](http://www.licht.de)

offers tips on correct lighting for a variety of domestic and commercial “lighting situations”. Explanations of technical terms are available at a click of the mouse. Product groups which figure in the lighting situations are linked to a “product/matrix”, where they are further linked to FGL members. Other site features include specimen pages of FGL print publications, hotlinks and a discussion forum.

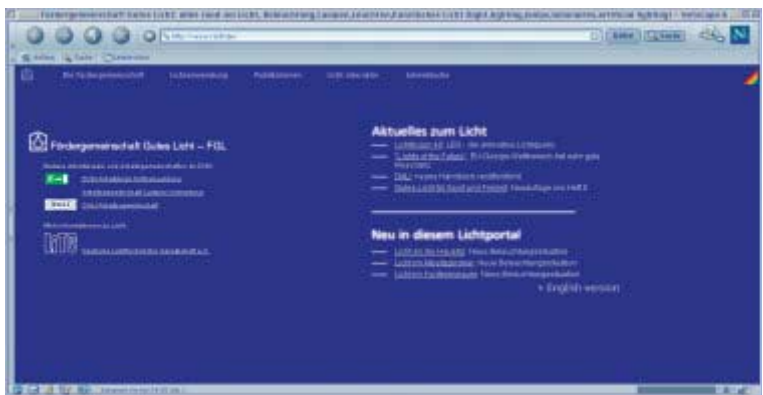
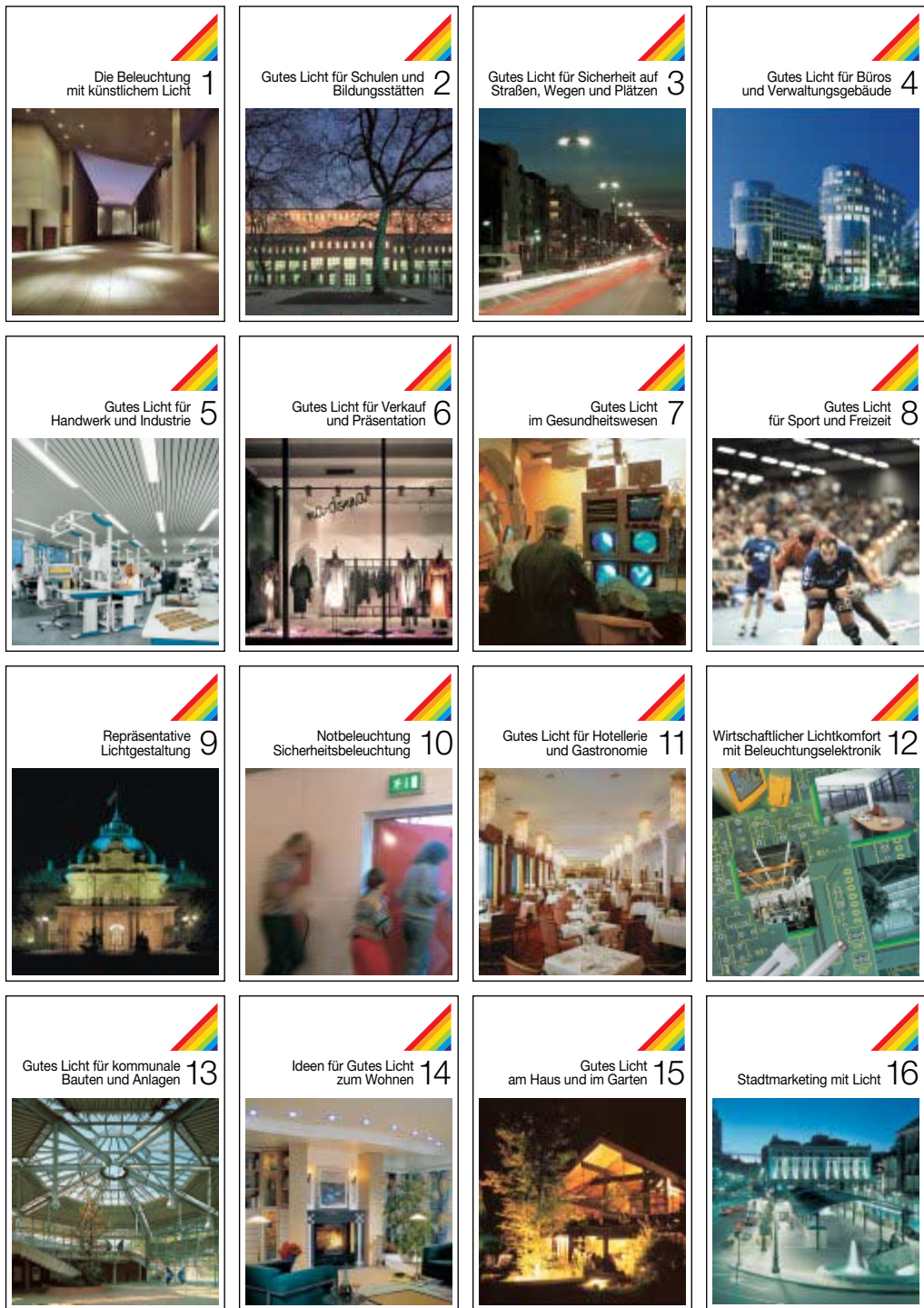

**Good Lighting for Offices  
and Office Buildings**



Fördergemeinschaft Gutes Licht

