

# Fire Alarm system Installation Guide

## FIRE ALARM SYSTEM CATEGORIES

Systems designed for Protection of Property only, fall into two classifications P1 or P2.

The objective of a Category P1 is to provide the earliest possible warning of a fire to minimise the time between ignition and the arrival of the fire fighters.

P1 is designed to protect the whole building whilst P2 is installed in defined parts of the building only, which may have an extraordinary high risk or hazard.

Life protection on the other hand will often depend on the number of people accessing a particular building and depending on the variations, the systems can range from simple Type M to L1 categories, these being detailed in the following diagrams.

These diagrams show a typical building with a number of escape routes, side rooms and open plan areas used for escape.

A Category M system requires manual call points on all exits as well as corridors where persons are not expected to walk more than 30/45m (see design note 3) to operate one.

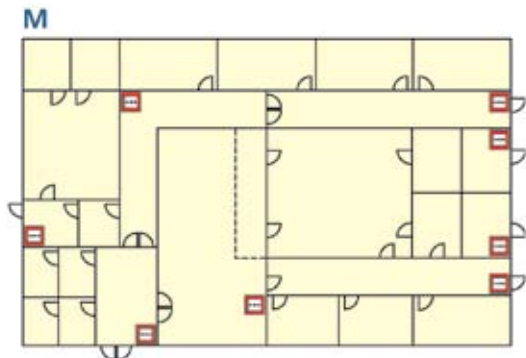

Category L5, designed for buildings that have a particular risk identified which warrants some special attention. For example if there is an area of high risk which is considered worthy of having some automatic detection

but a manual system is also needed, then this will be termed as L5/M.

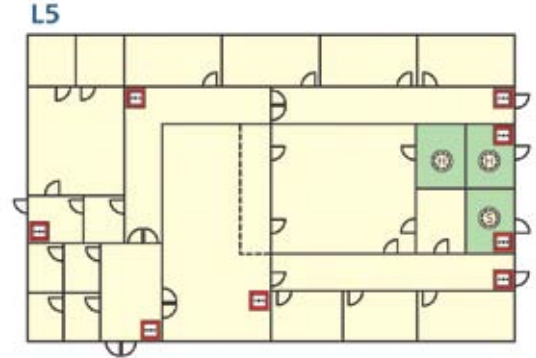

Category L4 provides detection within the escape routes only, whereas L3 not only covers these areas but all rooms leading onto the escape route. The reasoning behind this is to alert people of the danger prior to the corridor becoming "Smoke logged" so people can escape safely.

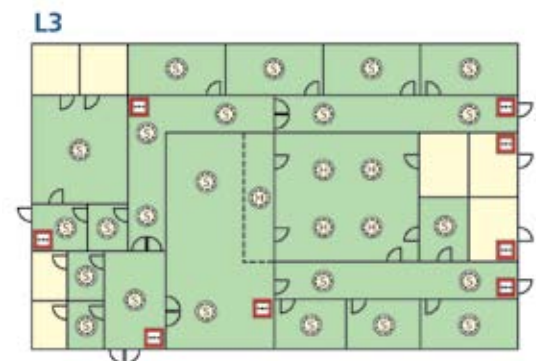
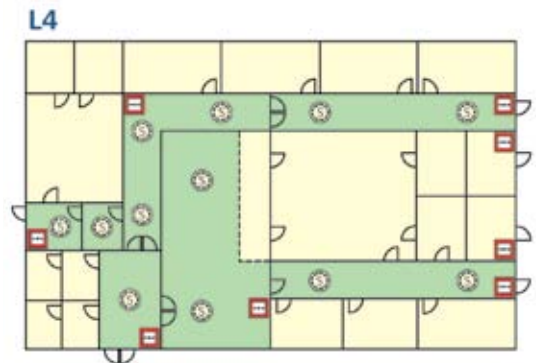

L2 is a further enhancement of protection with all the areas covered by an L3 category as well as all high risk areas such as boiler rooms etc

### L2

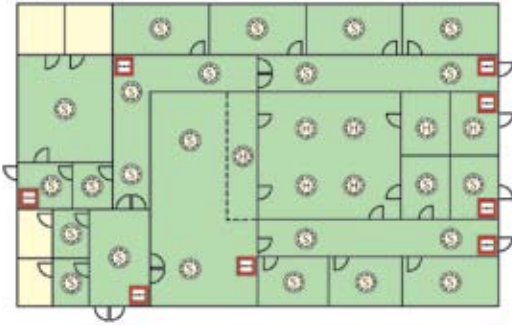

L1 provides protection throughout the building, and also where Property Protection is the prime reason for the system (this allows for a choice between the P1 or P2 categories).

### L1

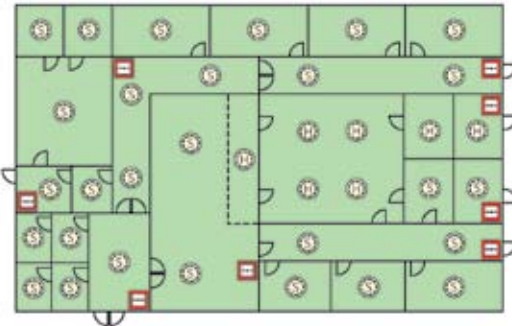

## DETECTION AND ALARM ZONES

Generally a building is broken down into smaller compartments to enable the fire fighters to locate the fire as quickly as possible.

Even if the system is addressable it is still considered beneficial to have a separate 'at a glance' indication of the location of the fire.

These compartments of a building are called detection zones, which need to comply with the following criteria.

### DETECTION ZONES

- o 3 A detection zone should cover no more than 1 storey, unless total floor area is less than 300m<sup>2</sup>. Voids in the same fire

compartment should be included in the same floor zone. The maximum floor area of a zone should not be greater than 2.000m<sup>2</sup>, except for some large open plan areas that incorporate manual call points only, which can be extended to 10.000m<sup>2</sup>. The maximum search distance for the fire fighters to see the seat of the fire within a zone should not exceed 60m assuming the route taken is the worst possible option. Vertical structures like stairwells, lift wells etc should be considered as separate zones.

- o A manual call point within a staircase should be connected to the zone associated with that floor and ideally be mounted on the accommodation side of the corridor exit. Automatic sensors on the stairwell remain as part of the stairwell detection zone.

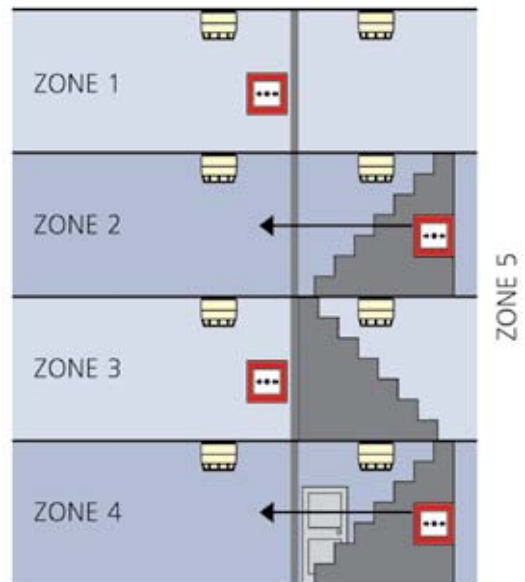

### ALARM ZONES

An alarm zone is clearly defined within the standard but generally is an area of the building coinciding with the fire compartment boundaries. There must be a clear break between these alarm zones to ensure alert and evacuation messages are not overheard from adjacent areas.

The only other criteria is that an alarm zone may consist of a number of detection zones but not visa versa.

Alarm zones are only required when

phased or staged evacuation is required. It is therefore important that care should be taken to ensure only one message is heard at any one time particularly where two alarm zones are attached.

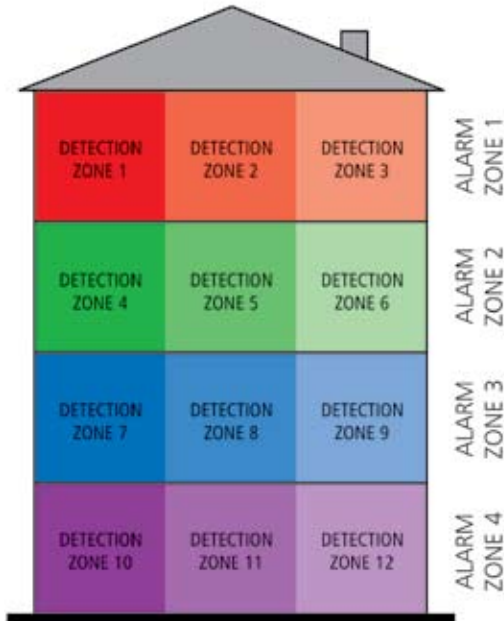

### SITING OF MANUAL CALL POINTS

All manual call points, whatever the system, should comply to BS EN54-11 single action Type

A version only and should be located as follows:

- o On all storey exits and all exits to open air irrespective of whether they are designated fire exits.
- o Nobody should travel more than 45 metres to reach one, except if the exit routes are undefined in which case the direct line distance should not exceed 30 metres.
- o The above distances to be reduced to 25 and 16 metres respectively, if there are persons with limited mobility or there is a likelihood of rapid fire development.
- o In all areas with potential high fire risk such as kitchens etc.
- o Where phased evacuation is planned, call points will need to be sited on all exits from a particular zone.

- o 1.4 metres + or – 200mm above the floor.
- o Call points fitted with protective hinged covers for whatever reason should be listed as a variation.

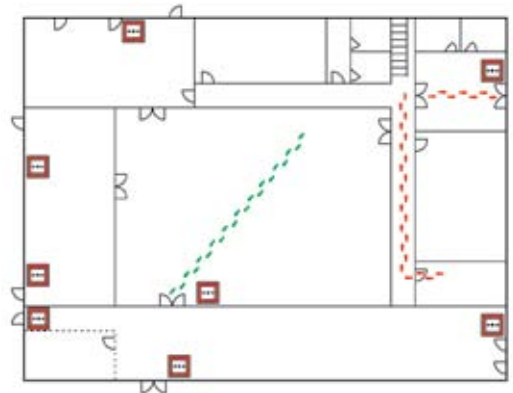

 Manual Call Point

 Route of travel  
45m max (defined)

 Route of travel  
30m max (undefined)

Note: In order to comply with the requirements of Building Regulations Approved Document M, which requires electrical switches including manual call points (MCPs) to be mounted at between 1M + or – 200mm on wheel chair access routes, these should be listed as a Variation on the certificate as BS requires MCP's to be mounted at 1.4M + or – 200mm.

### SELECTION AND SITING OF SENSORS

For further advice please refer to clauses 21 & 22 of BS 5839-1:2002

The objective is to select the correct sensor for the appropriate application, to provide the earliest warning of fire without the risk of a false alarm.

It is therefore worth trying to visualize the type of fire that is likely to occur in a particular room or area and also to familiarise oneself with the application and the risks that could give rise to a false alarm.

HEAT detector spacing (Under flat horizontal ceiling)

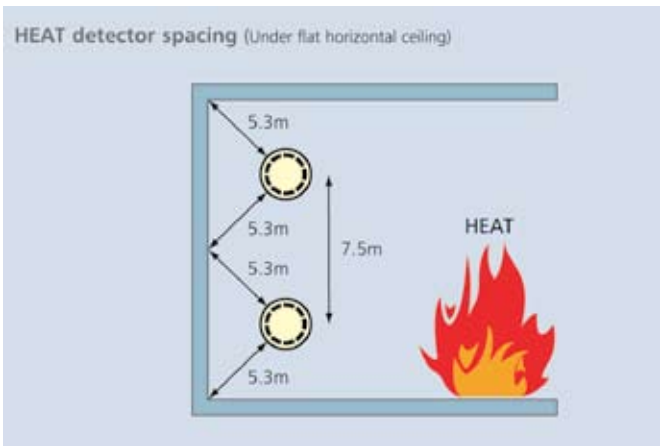

**SMOKE SENSORS  
COMPLYING TO BS EN54-7**

Traditionally, 'point' type smoke sensors have fallen into two main categories, optical or ionisation.

Due to new European Directives for the storage and transport of radioactive sources, ionisation sensors are becoming less favourable and are being replaced by multi-sensors that utilise single or dual optical chambers that are also combined with heat and/or carbon monoxide sensing elements. This creates a whole range of sensors that are suitable for detecting different types of fires and yet ignore signals that previously have led to false alarms such as white dust or steam particles.

The table below shows the various 'states' of these smoke sensor options. This should be read in conjunction with the attached application/risk charts to ensure the correct sensor is used for a particular location.

SMOKE & HEAT detector spacing in corridors (category P only)

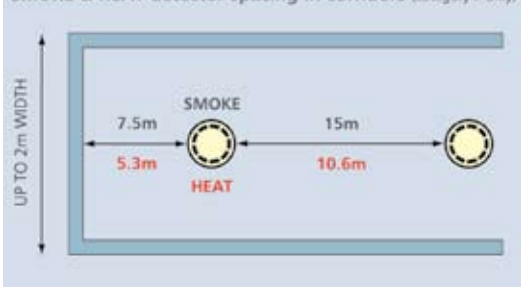

SMOKE detector under pitched roofs

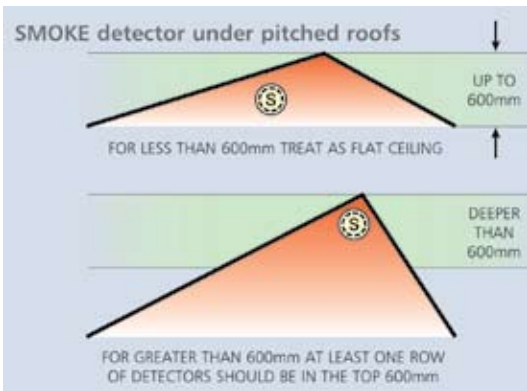

SMOKE detector spacing (Under flat horizontal ceiling)

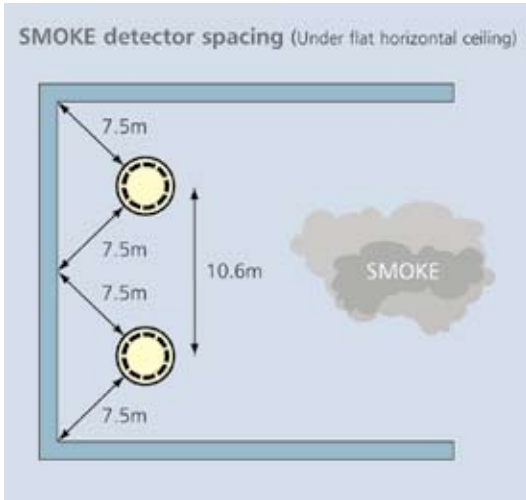

Mounting detectors in voids

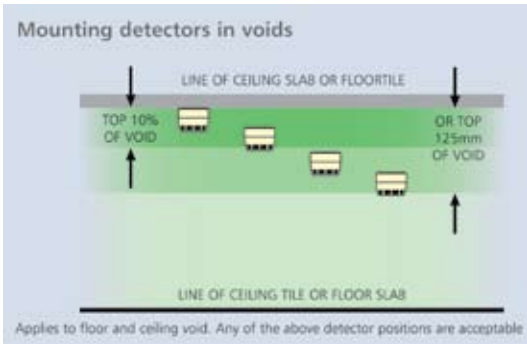

### Limits of siting sensors near obstacles or walls

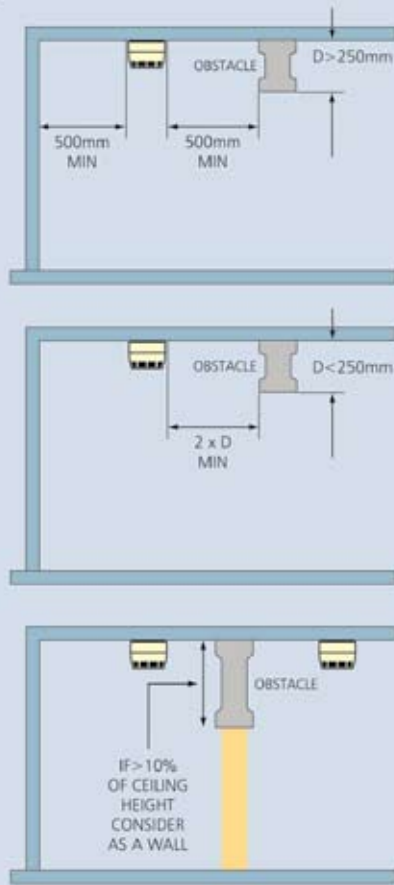

### Ceilings with multiple joists

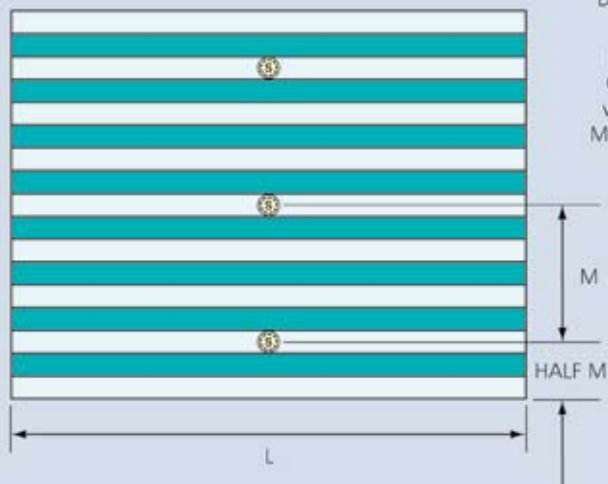

PERMITTED SPACING  
DETAILED IN TABLE  
BELOW

RATIO BETWEEN  
CEILING HEIGHTS  
vs BEAM DEPTH &  
MAXIMUM SPACING  
'M'



## Ceilings with multiple joists

Ceiling Height (H)	Beam Depth (D)	Smoke Sensor Spacing (M)	Heat Sensor Spacing (M)
6m or less	Less than 10% H	5m	3.8m
More than 6m	Less than 10% H and 600mm or less	5m	3.8m
More than 6m	Less than 10% H and more than 600mm	5m	3.8m
3m or less	More than 10% H	2.3m	1.5m
4m	More than 10% H	2.8m	2.0m
5m	More than 10% H	3.0m	2.3m
6m or more	More than 10% H	3.3m	2.5m

### Obstructions

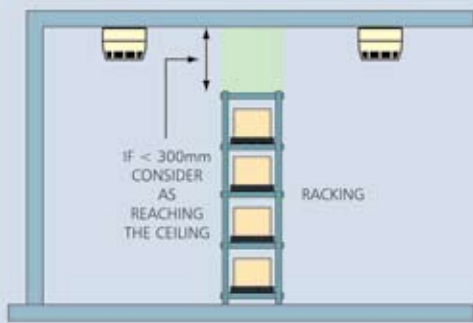

### Ceilings above racking



### Ceilings with other obstructions or Air Handling units etc

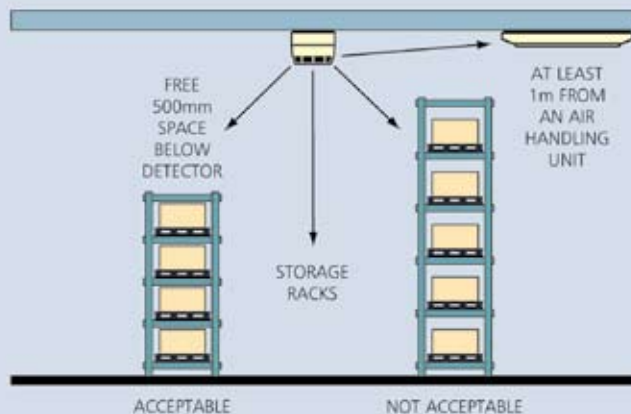

One of the most common mistakes is to mount a smoke sensor adjacent to the air conditioning intake or outlet grill. The minimum distance between the two should be at least 1 metre and further if possible. This is due to the fact that smoke may have difficulty penetrating the sensor when the air conditioning is switched on. Also there is a greater risk of the sensor becoming contaminated and giving rise to false alarms.

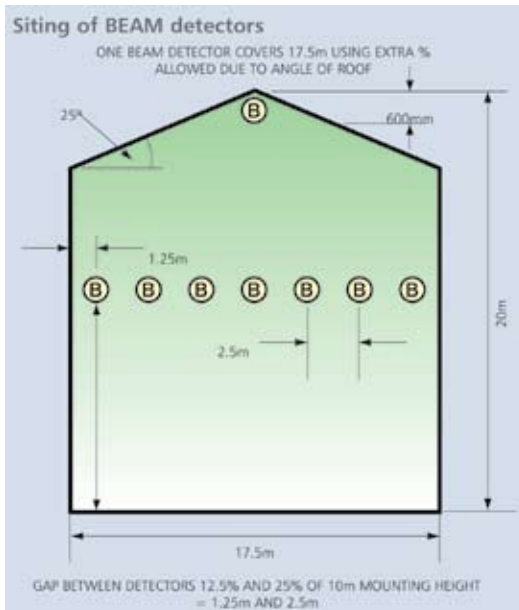
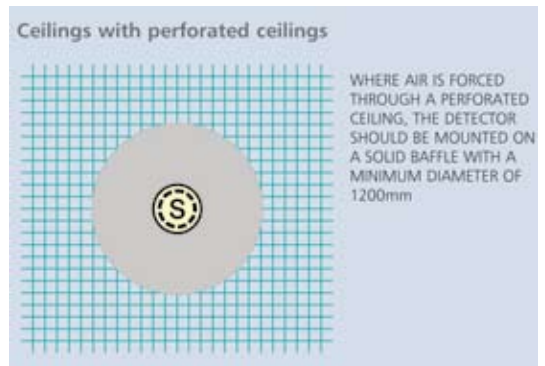
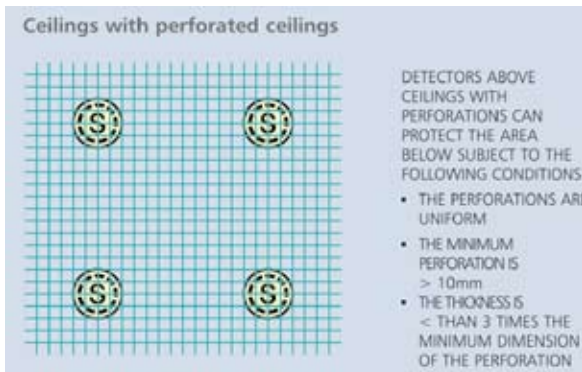

## CHOICE AND SITING OF ALARM SOUNDERS AND VISUAL ALARMS

Sounders and strobes are generally provided for systems designed to protect life. However on the rare occasion when only the property is being protected it is still essential to mount a sounder adjacent to the fire control panel as well as immediately outside the main entrance for the fire fighters.

Before deciding on the number and location of sounder/visual, alarms it is important to establish what the 'Fire Plan' or cause and effect will be.

If the building is not going to have a one 'out all' out arrangement the evacuation procedures must be established. Once this is known you can then establish the alarm zone areas where different alarm messages may be given for example an alert or an evacuation tone.

*Research over the last twenty years has proven that a voice enhanced sounder is preferred to a bell or electronic sounder as people pay more attention to a spoken message.*

**\*Illustrations courtesy of Gent**

- o General rules apply as for point detectors
- o For apex ceilings extend coverage by %1 for each degree of angle
- o 600mm from the highest point
- o Avoid beams close to walls (500mm) or where temporary obstructions may occur
- o Mount transmitter & receivers on a solid surface not affected by wind natural temperature changes
- o Additional units may be included in atria to detect at lower, levels to counter stratification effect



*Systems and Equipment cannot be reliable unless properly maintained by professionals on a yearly basis*

## INSTALLATION & PLACEMENT OF CO DETECTOR

If locating the CO alarm in a room with an appliance:

- o The alarm should be located between 1m and 3m horizontally from the appliance and between 1.85m and 3m from the appliance
- o The alarm should be located preferably on the ceiling, at least 300mm from any wall

- o If placed on a wall, the CO alarm should be as high as possible but not within 150mm of the ceiling

If locating the CO alarm in a room remote from the appliance:

- o The alarm should be located at a level similar to the breathing zone of the occupant (typically 1.5m to 2m above floor level and in bedrooms at the height of the bed)

